

Operating Instructions

External display and adjustment unit for
4 ... 20 mA/HART sensors

VEGADIS 82

4 ... 20 mA/HART



Document ID: 45300



VEGA

Contents

1	About this document	4
1.1	Function	4
1.2	Target group	4
1.3	Symbols used.....	4
2	For your safety	5
2.1	Authorised personnel	5
2.2	Appropriate use.....	5
2.3	Warning about incorrect use.....	5
2.4	General safety instructions	5
2.5	EU conformity.....	6
2.6	NAMUR recommendations	6
2.7	Installation and operation in the USA and Canada	6
2.8	Environmental instructions	6
3	Product description	7
3.1	Configuration.....	7
3.2	Principle of operation.....	8
3.3	Packaging, transport and storage.....	10
3.4	Accessories.....	10
4	Mounting	12
4.1	General instructions	12
4.2	Mounting instructions	12
5	Connecting to power supply	15
5.1	Preparing the connection	15
5.2	Connection technology and steps	16
5.3	Wiring plan	18
5.4	Connection to HART systems	18
5.5	Connection to a controller or four-wire sensor	19
5.6	Connection example	21
5.7	Switch-on phase.....	22
6	Set up with the display and adjustment module	23
6.1	Short description	23
6.2	Insert display and adjustment module	23
6.3	Adjustment system.....	24
6.4	Measured value indication - Selection of national language	25
6.5	Start menu.....	26
6.6	Parameter adjustment - VEGADIS 82.....	26
6.7	Parameter adjustment - VEGAPULS WL 61	31
6.8	Parameter adjustment - VEGAWELL 52	43
6.9	Parameter adjustment - Sensors from other manufacturers via Generic HART	48
7	Setup via PACTware	52
7.1	Connect the PC	52
7.2	Parameter adjustment with PACTware	53
7.3	Saving the parameterisation data	54
8	Diagnostics and servicing	55
8.1	Maintenance	55

8.2	Diagnostics	55
8.3	Rectify faults.....	56
8.4	Exchanging the electronics module.....	57
8.5	Software update	57
8.6	How to proceed if a repair is necessary.....	57
9	Dismount.....	59
9.1	Dismounting steps.....	59
9.2	Disposal	59
10	Supplement	60
10.1	Technical data	60
10.2	HART communication, HART commands	63
10.3	Dimensions	64
10.4	Industrial property rights.....	67
10.5	Trademark.....	67



Safety instructions for Ex areas

Take note of the Ex specific safety instructions for Ex applications. These instructions are attached as documents to each instrument with Ex approval and are part of the operating instructions.

Editing status: 2021-02-15

1 About this document

1.1 Function

This instruction provides all the information you need for mounting, connection and setup as well as important instructions for maintenance, fault rectification, the exchange of parts and the safety of the user. Please read this information before putting the instrument into operation and keep this manual accessible in the immediate vicinity of the device.

1.2 Target group

This operating instructions manual is directed to trained personnel. The contents of this manual must be made available to the qualified personnel and implemented.

1.3 Symbols used



Document ID

This symbol on the front page of this instruction refers to the Document ID. By entering the Document ID on www.vega.com you will reach the document download.



Information, note, tip: This symbol indicates helpful additional information and tips for successful work.



Note: This symbol indicates notes to prevent failures, malfunctions, damage to devices or plants.



Caution: Non-observance of the information marked with this symbol may result in personal injury.



Warning: Non-observance of the information marked with this symbol may result in serious or fatal personal injury.



Danger: Non-observance of the information marked with this symbol results in serious or fatal personal injury.



Ex applications

This symbol indicates special instructions for Ex applications.



List

The dot set in front indicates a list with no implied sequence.



Sequence of actions

Numbers set in front indicate successive steps in a procedure.



Battery disposal

This symbol indicates special information about the disposal of batteries and accumulators.

2 For your safety

2.1 Authorised personnel

All operations described in this documentation must be carried out only by trained, qualified personnel authorised by the plant operator.

During work on and with the device, the required personal protective equipment must always be worn.

2.2 Appropriate use

The VEGADIS 82 is suitable for measured value indication and adjustment of 4 ... 20 mA/HART sensors.

You can find detailed information about the area of application in chapter " *Product description*".

Operational reliability is ensured only if the instrument is properly used according to the specifications in the operating instructions manual as well as possible supplementary instructions.

2.3 Warning about incorrect use

Inappropriate or incorrect use of this product can give rise to application-specific hazards, e.g. vessel overfill through incorrect mounting or adjustment. Damage to property and persons or environmental contamination can result. Also, the protective characteristics of the instrument can be impaired.

2.4 General safety instructions

This is a state-of-the-art instrument complying with all prevailing regulations and directives. The instrument must only be operated in a technically flawless and reliable condition. The operator is responsible for the trouble-free operation of the instrument. When measuring aggressive or corrosive media that can cause a dangerous situation if the instrument malfunctions, the operator has to implement suitable measures to make sure the instrument is functioning properly.

During the entire duration of use, the user is obliged to determine the compliance of the necessary occupational safety measures with the current valid rules and regulations and also take note of new regulations.

The safety instructions in this operating instructions manual, the national installation standards as well as the valid safety regulations and accident prevention rules must be observed by the user.

For safety and warranty reasons, any invasive work on the device beyond that described in the operating instructions manual may be carried out only by personnel authorised by the manufacturer. Arbitrary conversions or modifications are explicitly forbidden. For safety reasons, only the accessory specified by the manufacturer must be used.

To avoid any danger, the safety approval markings and safety tips on the device must also be observed.

2.5 EU conformity

The device fulfils the legal requirements of the applicable EU directives. By affixing the CE marking, we confirm the conformity of the instrument with these directives.

The EU conformity declaration can be found on our homepage.

2.6 NAMUR recommendations

NAMUR is the automation technology user association in the process industry in Germany. The published NAMUR recommendations are accepted as the standard in field instrumentation.

The device fulfils the requirements of the following NAMUR recommendations:

- NE 21 – Electromagnetic compatibility of equipment
- NE 53 – Compatibility of field devices and display/adjustment components

For further information see www.namur.de.

2.7 Installation and operation in the USA and Canada

This information is only valid for USA and Canada. Hence the following text is only available in the English language.

Installations in the US shall comply with the relevant requirements of the National Electrical Code (ANSI/NFPA 70).

Installations in Canada shall comply with the relevant requirements of the Canadian Electrical Code.

2.8 Environmental instructions

Protection of the environment is one of our most important duties.

That is why we have introduced an environment management system with the goal of continuously improving company environmental protection. The environment management system is certified according to DIN EN ISO 14001.

Please help us fulfil this obligation by observing the environmental instructions in this manual:

- Chapter "*Packaging, transport and storage*"
- Chapter "*Disposal*"

3 Product description

3.1 Configuration

Type label

The type label contains the most important data for identification and use of the instrument:

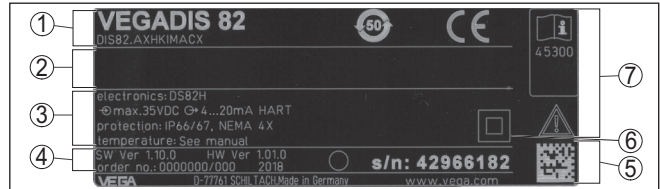

Fig. 1: Layout of the type label (example)

- 1 Instrument type, product code
- 2 Field for approvals
- 3 Technical data
- 4 hardware/software version, order number
- 5 serial number of the device, QR code for device documentation
- 6 Device protection class
- 7 Reminder to observe the instrument documentation

Serial number - Instrument search

The type label contains the serial number of the instrument. With it you can find the following instrument data on our homepage:

- Product code (HTML)
- Delivery date (HTML)
- Order-specific instrument features (HTML)
- Operating instructions at the time of shipment (PDF)

Move to "www.vega.com" and enter in the search field the serial number of your instrument.

As an alternative, you can access these data via your smartphone:

- Download the VEGA Tools app from the "Apple App Store" or the "Google Play Store"
- Scan the DataMatrix code on the type label of the instrument or
- Enter the serial number manually in the app

Instrument versions

The VEGADIS 82 is available in different housing materials, see chapter "Technical data".

The instrument is optionally available with or without display and adjustment module.

Scope of this operating instructions

This operating instructions manual applies to the following instrument versions:

- Software from 1.12.00
- Hardware from 1.00.00

Scope of delivery

The scope of delivery encompasses:

- VEGADIS 82
- Display and adjustment module (optional)

- Mounting accessories (optional)
- Documentation
 - This operating instructions manual
 - Ex-specific "*Safety instructions*" (with Ex versions)
 - If necessary, further certificates



Information:

Optional instrument features are also described in this operating instructions manual. The respective scope of delivery results from the order specification.

3.2 Principle of operation

Application area

VEGADIS 82 is suitable for measured value indication and adjustment of sensors with HART protocol. The instrument is looped directly into the 4 ... 20 mA HART signal line at any location. Separate external energy is not necessary. VEGADIS 82 also operates exclusively as an indicating instrument in a 4 ... 20 mA current loop.

Sensors

The instrument is particularly designed for:

- VEGAPULS WL 61
- VEGAWELL 52

These sensors have no own display/adjustment.

The housing of VEGADIS 82 contains a filter element for ventilation. The instrument is thus also used for atmospheric pressure compensation for a submersible pressure transmitter.

The VEGADIS 82 can also be used as an external indicating device for a four-wire sensor or a controller VEGAMET with active 4 ... 20 mA output.

Sensor adjustment

The sensor adjustment is carried out in the VEGADIS 82 integrated in the display and adjustment module.



Note:

The operation of a display and adjustment module with integrated Bluetooth function is not supported by VEGADIS 82.

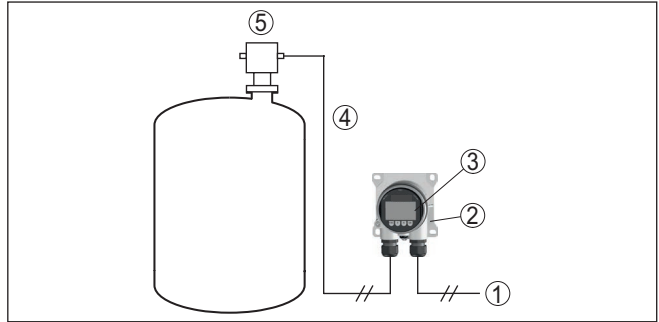

Fig. 2: Connection of the VEGADIS 82 to the sensor, adjustment via the display and adjustment module

- 1 Voltage supply/Signal output sensor
- 2 VEGADIS 82
- 3 Display and adjustment module
- 4 4 ... 20 mA/HART signal cable
- 5 Sensor

Sensor adjustment via PC with PACTware

The sensor adjustment is carried out via a PC with PACTware/DTM.

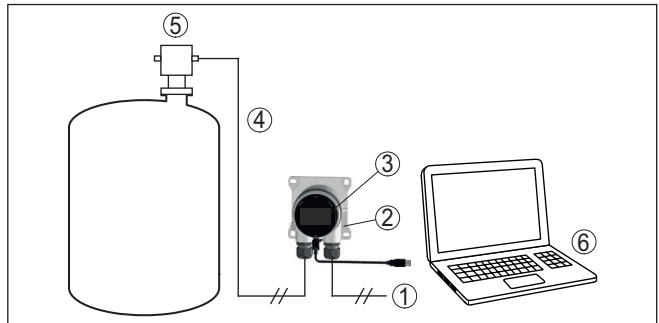

Fig. 3: Connection of the VEGADIS 82 to the sensor and the PC, adjustment via PC with PACTware

- 1 Voltage supply/Signal output sensor
- 2 VEGADIS 82
- 3 VEGACONNECT
- 4 4 ... 20 mA/HART signal cable
- 5 Sensor
- 6 PC with PACTware/DTM

Modes

4 ... 20 mA mode: when connected to a 4 ... 20 mA signal cable, VEGADIS 82 operates exclusively as a display instrument.

Adjustment range: Indication scaling VEGADIS 82

HART mode: when operated with a 4 ... 20 mA/HART sensor, the VEGADIS 82 operates as display and HART adjustment instrument.

The parameter adjustment of the sensor is carried out via HART communication. During the parameter adjustment, the VEGADIS 82 operates as a Primary or Secondary Master to the sensor.

Adjustment range: Sensor adjustment, indication scaling VEGADIS 82

HART multidrop: the VEGADIS 82 can be also used as an indicating device for a bus participant in a HART multidrop system.

Adjustment range: Sensor adjustment for a bus participant, indication scaling VEGADIS 82

3.3 Packaging, transport and storage

Packaging

Your instrument was protected by packaging during transport. Its capacity to handle normal loads during transport is assured by a test based on ISO 4180.

The packaging of standard instruments consists of environment-friendly, recyclable cardboard. For special versions, PE foam or PE foil is also used. Dispose of the packaging material via specialised recycling companies.

Transport

Transport must be carried out in due consideration of the notes on the transport packaging. Nonobservance of these instructions can cause damage to the device.

Transport inspection

The delivery must be checked for completeness and possible transit damage immediately at receipt. Ascertained transit damage or concealed defects must be appropriately dealt with.

Storage

Up to the time of installation, the packages must be left closed and stored according to the orientation and storage markings on the outside.

Unless otherwise indicated, the packages must be stored only under the following conditions:

- Not in the open
- Dry and dust free
- Not exposed to corrosive media
- Protected against solar radiation
- Avoiding mechanical shock and vibration

Storage and transport temperature

- Storage and transport temperature see chapter " *Supplement - Technical data - Ambient conditions* "
- Relative humidity 20 ... 85 %

Lifting and carrying

With instrument weights of more than 18 kg (39.68 lbs) suitable and approved equipment must be used for lifting and carrying.

3.4 Accessories

PLICSCOM

The display and adjustment module PLICSCOM is used for measured value indication, adjustment and diagnosis.

VEGACONNECT

The interface adapter VEGACONNECT enables the connection of communication-capable instruments to the USB interface of a PC.

Sun shade

The sun protection protects the device from direct sunlight and thus prevents overheating of the electronics. It also improves the readability of the display when exposed to sunlight. The sun protection can be used for wall and pipe mounting.

4 Mounting

4.1 General instructions

Installation position

VEGADIS 82 functions in any installation position.

Protection against moisture

Protect your instrument against moisture ingress through the following measures:

- Use a suitable connection cable (see chapter " *Connecting to power supply*")
- Tighten the cable gland or plug connector
- Lead the connection cable downward in front of the cable entry or plug connector

This applies mainly to outdoor installations, in areas where high humidity is expected (e.g. through cleaning processes) and on cooled or heated vessels.



Note:

Make sure that during installation or maintenance no moisture or dirt can get inside the instrument.

To maintain the housing protection, make sure that the housing lid is closed during operation and locked, if necessary.

4.2 Mounting instructions

Wall mounting

The VEGADIS 82 in all available housing materials is suitable for wall mounting.

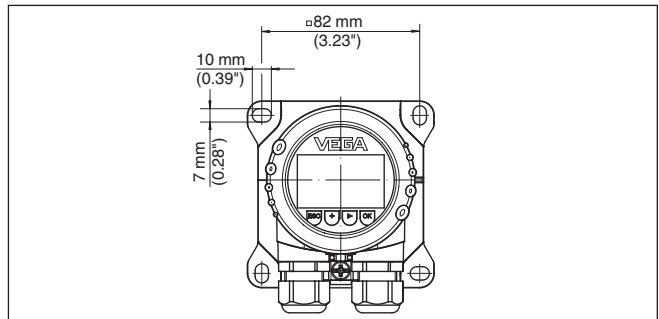

Fig. 4: Drilling dimensions for VEGADIS 82 for wall mounting

Carrier rail mounting

The VEGADIS 82 with plastic housing is suitable for direct carrier rail mounting according to EN 50022.

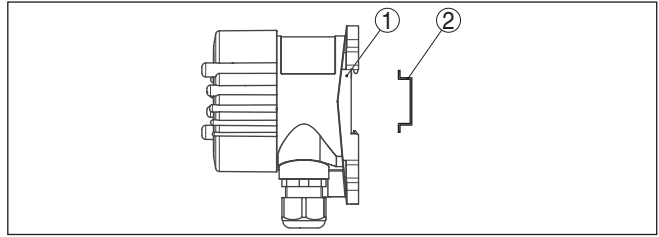

Fig. 5: VEGADIS 82 with plastic housing for carrier rail mounting

- 1 Base
- 2 Carrier rail

The versions with aluminium or stainless steel housing for carrier rail mounting according to EN 50022 are supplied with unassembled mounting accessories. The kit consists of an adapter plate and four mounting screws M6 x 12.

The adapter plate is screwed to the base of VEGADIS 82 by the user.

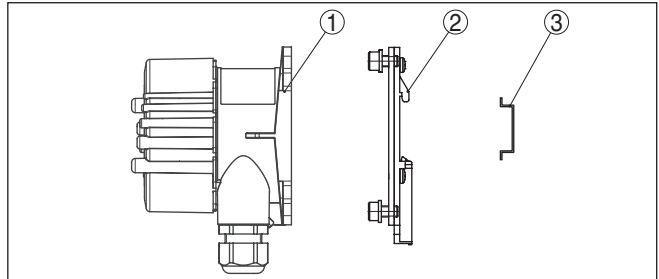

Fig. 6: VEGADIS 82 with aluminium and stainless steel housing for carrier rail mounting

- 1 Base
- 2 Adapter plate with screws M6 x 12
- 3 Carrier rail

Tube mounting

The VEGADIS 82 for tube mounting is supplied with unassembled mounting accessories. The kit consists of two pairs of mounting brackets and four mounting screws M6 x 100.

The mounting brackets are screwed to the base of VEGADIS 82 by the user.

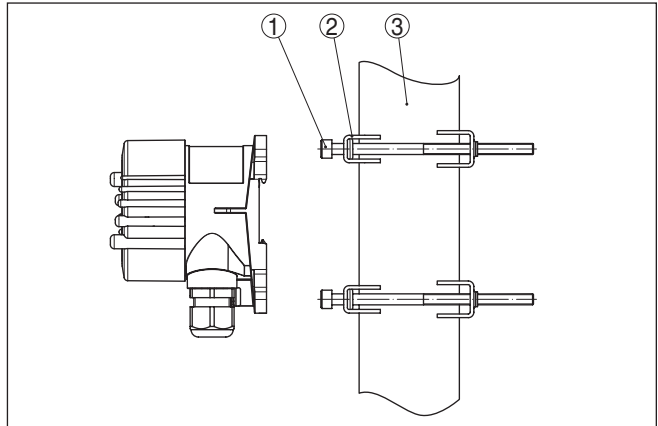

Fig. 7: VEGADIS 82 for tube mounting

- 1 4 screws M6 x 100
- 2 Mounting brackets
- 3 Tube (diameter 1" to 2")

Front panel mounting

The VEGADIS 82 is also available with a plastic housing for panel mounting. The housing is fastened to the rear of the panel by means of the supplied screw clamps.

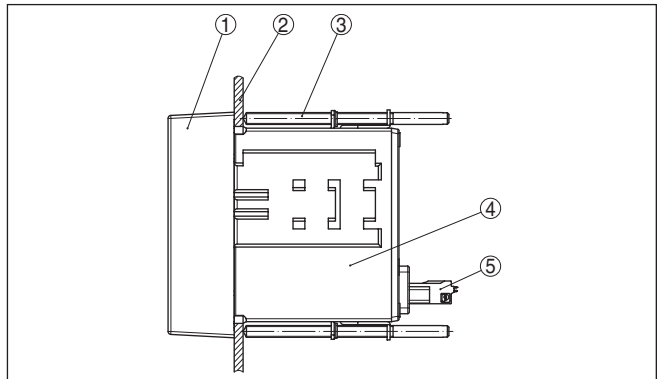

Fig. 8: VEGADIS 82 for panel mounting

- 1 Inspection window
- 2 Front panel
- 3 Screw clamp
- 4 Housing
- 5 Plug connector

5 Connecting to power supply

5.1 Preparing the connection

Safety instructions

Always keep in mind the following safety instructions:

- Carry out electrical connection by trained, qualified personnel authorised by the plant operator
- If overvoltage surges are expected, overvoltage arresters should be installed



Warning:

Only connect or disconnect in de-energized state.

Voltage supply

Power supply and current signal are carried on the same two-wire cable. The voltage supply range can differ depending on the sensor version.

The data for power supply are specified in chapter " *Technical data*".



Note:

Power the instrument via an energy-limited circuit (power max. 100 W) acc. to IEC 61010-1, e.g.

- Class 2 power supply unit (acc. to UL1310)
- SELV power supply unit (safety extra-low voltage) with suitable internal or external limitation of the output current

Keep in mind the following additional factors that influence the operating voltage:

- Output voltage of the power supply unit can be lower under nominal load (with a sensor current of 20.5 mA resp. 22 mA in case of fault message)
- Voltage loss on the VEGADIS 82 (see supply circuit in chapter " *Technical data*")

You can find information on the load resistance in chapter " *Technical data*", (voltage supply of the respective sensor)

Connection cable

The instrument is connected with standard two-wire cable without shielding. If electromagnetic interference is expected which is above the test values of EN 61326-1 for industrial areas, shielded cable should be used.

We generally recommend the use of shielded cable for HART mode.

Use cable with round cross-section. To ensure the seal effect of the cable gland (IP protection rating), find out which cable outer diameter the cable gland is suitable for. Use a cable gland fitting the cable diameter.

You can find an overview of the cable glands in chapter " *Technical data*".

Cable glands

Metric threads

In the case of instrument housings with metric thread, the cable glands are screwed in at the factory. They are sealed with plastic plugs as transport protection.

**Note:**

You have to remove these plugs before electrical connection.

NPT thread

In the case of instrument housings with self-sealing NPT threads, it is not possible to have the cable entries screwed in at the factory. The free openings for the cable glands are therefore covered with red dust protection caps as transport protection.

**Note:**

Prior to setup you have to replace these protective caps with approved cable glands or close the openings with suitable blind plugs.

On plastic housings, the NPT cable gland or the Conduit steel tube must be screwed into the threaded insert without grease.

Max. torque for all housings, see chapter " *Technical data*".

Cable screening and grounding

If shielded cable is necessary, we recommend connecting the cable shield on both ends to ground potential. In the VEGADIS 82, the shield should be connected directly to the internal ground terminal.



In Ex systems it must be ensured that the grounding complies with the installation regulations.

In electroplating plants as well as plants for cathodic corrosion protection it must be taken into account that significant potential differences exist. This can lead to unacceptably high currents in the cable screen if it is grounded at both ends.

5.2 Connection technology and steps**Connection technology**

The voltage supply and signal output are connected via the spring-loaded terminals in the housing.

Connection to the display and adjustment module or to the interface adapter is carried out via contact pins in the housing.

**Information:**

The terminal block is pluggable and can be removed from the electronics. To do this, lift the terminal block with a small screwdriver and pull it out. When reinserting the terminal block, you should hear it snap in.

Connection procedure

Proceed as follows:

1. Unscrew the housing lid
2. If a display and adjustment module is installed, remove it by turning it slightly to the left
3. Loosen compression nut of the cable gland and remove blind plug
4. Remove approx. 10 cm (4 in) of the cable mantle, strip approx. 1 cm (0.4 in) of insulation from the ends of the individual wires
5. Insert the cable into the sensor through the cable entry

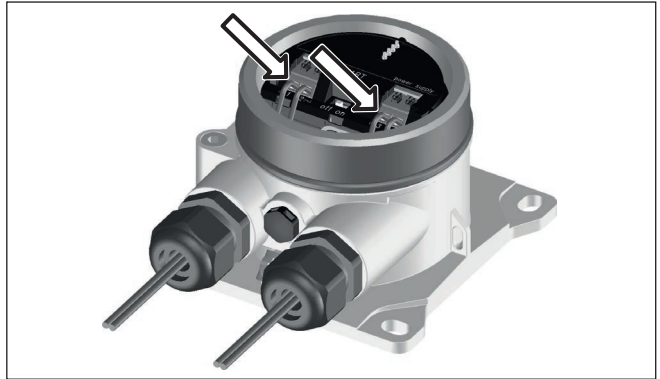

Fig. 9: Connection steps 5 and 6

6. Insert the wire ends into the terminals according to the wiring plan



Information:

Solid cores as well as flexible cores with wire end sleeves are inserted directly into the terminal openings. In case of flexible cores without end sleeves, press the terminal from above with a small screwdriver, the terminal opening is then free. When the screwdriver is released, the terminal closes again.

You can find further information on the max. wire cross-section under "*Technical data - Electromechanical data*".

7. Check the hold of the wires in the terminals by lightly pulling on them
8. Connect the shielding to the internal ground terminal, connect the external ground terminal to potential equalisation
9. Tighten the compression nut of the cable entry gland. The seal ring must completely encircle the cable
10. Reinsert the display and adjustment module, if one was installed
11. Screw the housing lid back on

5.3 Wiring plan

Wiring plan

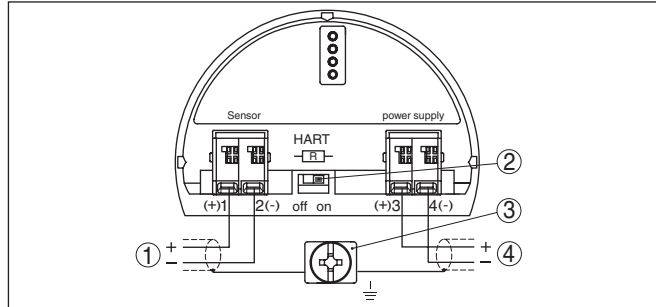

Fig. 10: Wiring plan VEGADIS 82 4 ... 20 mA/HART

- 1 To the sensor
- 2 Switch for HART resistor (on = activated, off = deactivated)
- 3 Terminal for connection of the cable screen
- 4 Processing system/PLC/Voltage supply

Wiring plan - Panel mounting

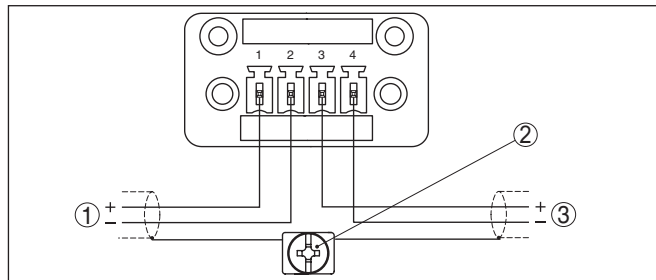

Fig. 11: Wiring plan VEGADIS 82 for 4 ... 20 mA sensors - panel mounting

- 1 To the sensor
- 2 Ground terminal in the switching cabinet for connection of the cable screen
- 3 Processing system/PLC/Voltage supply

5.4 Connection to HART systems

The following illustrations show the use of VEGADIS 82 in conjunction with one or several HART sensors.



Note:

With voltage supply via a VEGAMET controller, a HART resistor is already integrated and active there. With voltage supply via a VEGATRENN separator, a HART resistor is already integrated and optionally active.

In such cases the HART resistor in VEGADIS 82 must be deactivated.

HART standard

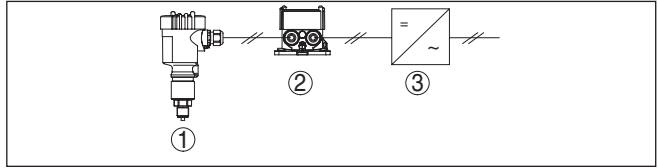

Fig. 12: VEGADIS 82 in conjunction with an individual sensor

- 1 Sensor
- 2 VEGADIS 82
- 3 Processing system/PLC/Voltage supply

HART multidrop

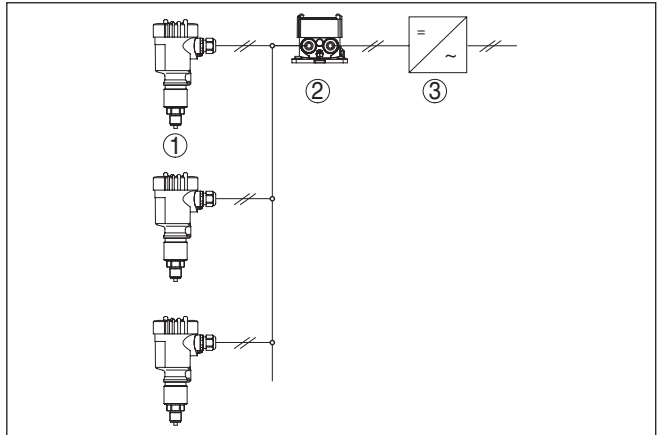

Fig. 13: One VEGADIS 82 for several sensors in a multidrop system

- 1 Sensor
- 2 VEGADIS 82
- 3 Processing system/PLC/Voltage supply

5.5 Connection to a controller or four-wire sensor

The following illustrations show the connection of VEGADIS 82 to a VEGAMET controller.

Controller VEGAMET

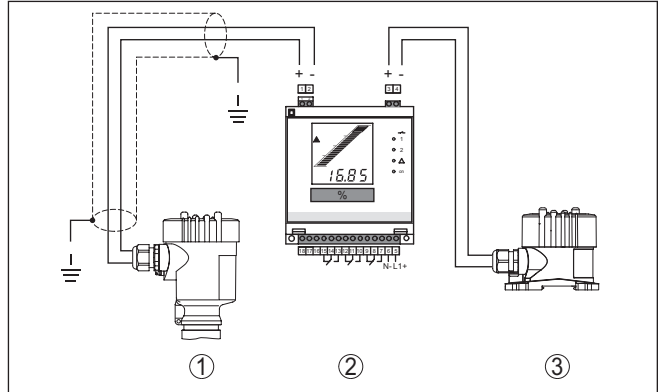

Fig. 14: Connection of VEGADIS 82 as external display to a controller

- 1 Sensor
- 2 Controller
- 3 VEGADIS 82

**Note:**

There terminals 1 and 2 on VEGADIS 82 must be bridged (see following illustration):

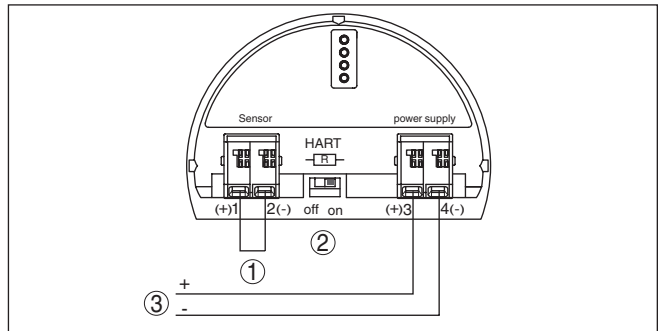

Fig. 15: Bridge between terminals 1 and 2 on the VEGADIS 82

- 1 Bridge
- 2 VEGADIS 82
- 3 Controller

Four-wire sensor

The following illustration shows the connection of VEGADIS 82 to a four-wire sensor with active 4 ... 20 mA output.

**Note:**

There terminals 1 and 4 on VEGADIS 82 must be bridged (see following illustration):

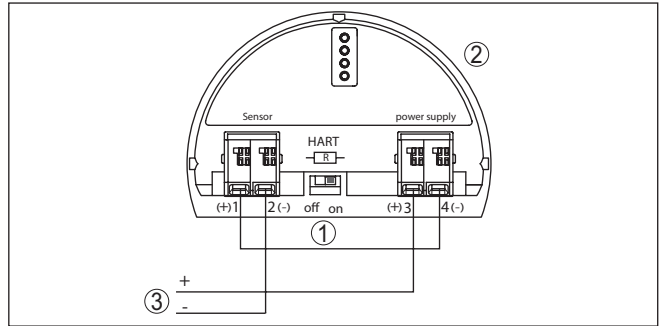

Fig. 16: Connection of VEGADIS 82 as external display to a four-wire sensor with active 4 ... 20 mA output

- 1 Bridge
- 2 VEGADIS 82
- 3 Four-wire sensor with active current output

The following illustration shows the connection of VEGADIS 82 to a four-wire sensor with active 4 ... 20 mA output and an additional processing system/PLC.

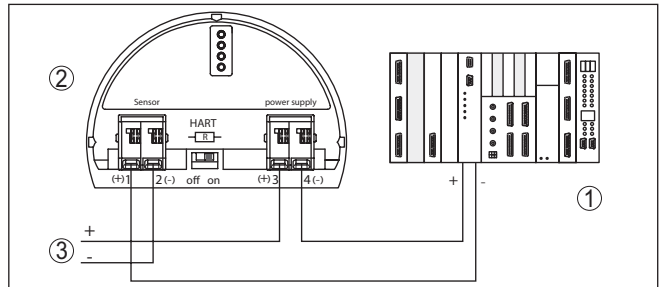

Fig. 17: Connection of VEGADIS 82 as external display to a four-wire sensors with active 4 ... 20 mA output with additional processing system/PLC

- 1 Processing system/PLC
- 2 VEGADIS 82
- 3 Four-wire sensor with active current output

5.6 Connection example

The following illustration shows the connection of VEGADIS 82 with a 4 ... 20 mA/HART sensor and processing system/PLC/voltage supply.

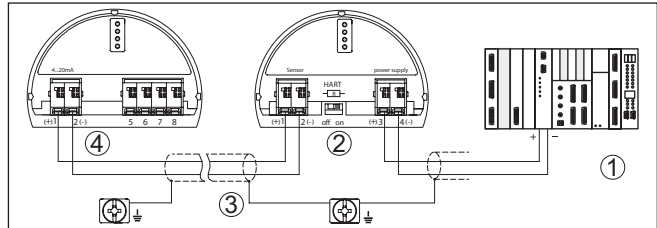

Fig. 18: Connection example 4 ... 20 mA/HART sensor and processing system/PLC

- 1 Processing system/PLC/Voltage supply
- 2 VEGADIS 82
- 3 Connection cable
- 4 4 ... 20 mA/HART sensor

5.7 Switch-on phase

After connecting the instrument to power supply or after a voltage recurrence, the instrument carries out a self-check for approx. 10 s:

- Internal check of the electronics
- Indication of the instrument type, hardware and software version, measurement loop name on the display or PC
- Indication of a status message on the display or PC

The duration of the warm-up phase depends on the connected sensor.

Then the actual measured value is displayed. You can find further information on the display in chapter "Measured value indication - Selection national language".

6 Set up with the display and adjustment module

Function/Configuration

6.1 Short description

The display and adjustment module is used for measured value display, adjustment and diagnosis. It can be mounted in the following housing versions and instruments:

- All continuously measuring sensors in single as well as double chamber housing version (optionally in the electronics or connection compartment)
- External display and adjustment unit



Note:

You can find detailed information on adjustment in the operating instructions manual "*Display and adjustment module*".

Mount/dismount display and adjustment module

6.2 Insert display and adjustment module

The display and adjustment module can be inserted into the VEGADIS 82 and removed again at any time. It is not necessary to interrupt the power supply.



Note:

The operation of a display and adjustment module with integrated Bluetooth function is not supported by VEGADIS 82.

Proceed as follows for mounting the display and adjustment module:

1. Unscrew the housing lid
2. Place the display and adjustment module in the desired position on the electronics (you can choose any one of four different positions - each displaced by 90°)
3. Press the display and adjustment module onto the electronics and turn it to the right until it snaps in
4. Screw housing lid with inspection window tightly back on

Disassembly is carried out in reverse order.

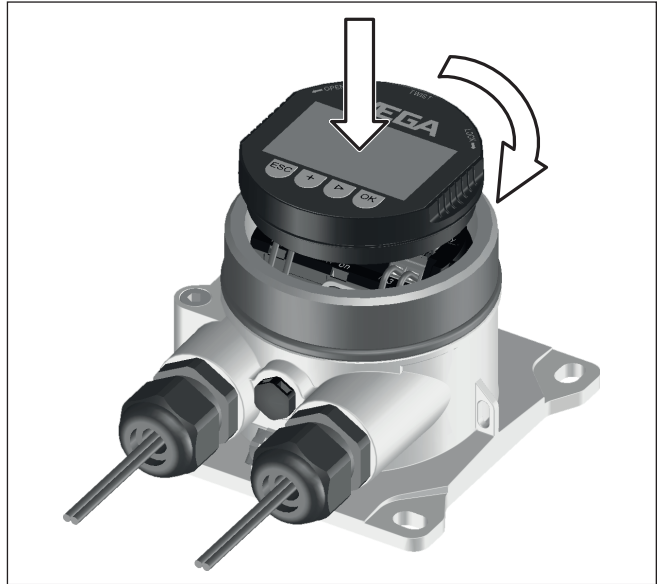

Fig. 19: Mounting of the display and adjustment module

6.3 Adjustment system

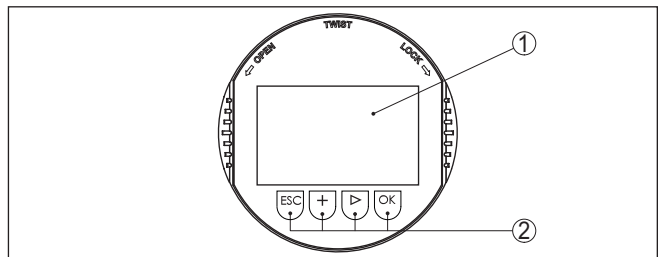

Fig. 20: Display and adjustment elements

- 1 LC display
- 2 Adjustment keys

Key functions

- **[OK]** key:
 - Move to the menu overview
 - Confirm selected menu
 - Edit parameter
 - Save value
- **[->]** key:
 - Change measured value presentation
 - Select list entry
 - Select menu items
 - Select editing position

- **[+]** key:
 - Change value of the parameter
- **[ESC]** key:
 - Interrupt input
 - Jump to next higher menu

Adjustment system

The instrument is operated via the four keys of the display and adjustment module. The individual menu items are shown on the LC display. You can find the function of the individual keys in the previous illustration.

Time functions

When the **[+]** and **[->]** keys are pressed quickly, the edited value, or the cursor, changes one value or position at a time. If the key is pressed longer than 1 s, the value or position changes continuously. When the **[OK]** and **[ESC]** keys are pressed simultaneously for more than 5 s, the display returns to the main menu. The menu language is then switched over to "English".

Approx. 60 minutes after the last pressing of a key, an automatic reset to measured value indication is triggered. Any values not confirmed with **[OK]** will not be saved.

6.4 Measured value indication - Selection of national language

Measured value indication

With the **[->]** key you can move between five different views:

- First view:** Display value 1 in big lettering, TAG number
- Second view:** Display value 1, a bargraph corresponding to the 4 ... 20 mA value, TAG number
- Third view:** Display values 1 and 2, TAG number
- Fourth view:** Display values 1, 2 and 3, TAG number
- Fifth view:** Display values 1, 2, 3 and 4, TAG number

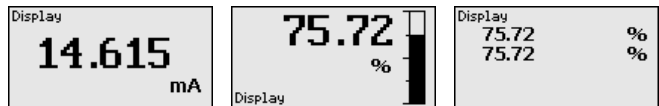

With the "OK" key you move (during the initial setup of the instrument) to the selection menu "Language".

Selection of national language

This menu item is used to select the national language for further parameter adjustment. A later change of the selection is possible via menu item "Setup - Display, Menu language".

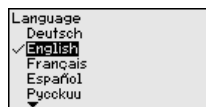

With the "OK" key you move to the start menu.

6.5 Start menu

Start menu

The start menu is divided into two sections with the following functions:

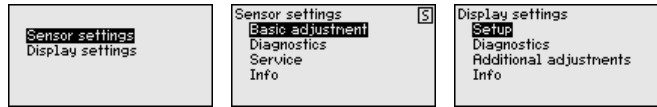

The selection branches into the following menus for parameter adjustment of the VEGADIS 82 or the connected sensor.



Note:

The symbol "S" is displayed in the upper right corner of the display if there is a HART connection to the sensor.

6.6 Parameter adjustment - VEGADIS 82

Main menu

The main menu is divided into four areas with the following functions:

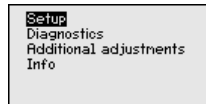

Setup: Settings, e.g. to measurement loop name, damping, scaling

Diagnosis: Information on the device status

Additional adjustments: Reset, copy display settings

Info: Instrument name, instrument version, date of manufacture, instrument features

For optimum adjustment of the instrument, the individual submenu items should be selected one after the other in the main menu item "Setup" and provided with the correct parameter values.

Setup - Measurement loop name

In the menu item "Measurement loop name" you edit a twelve digit measurement loop designation label.

You can enter an unambiguous designation for the measured value, e.g. the measurement loop name or the tank or product designation. In digital systems and in the documentation of larger plants, a singular designation must be entered for exact identification of individual measuring points.

The character set comprises the following ASCII signs with extension according to ISO 8859-1:

- Letters from A ... Z
- Numbers from 0 ... 9
- Special characters such as +, -, /, - etc.

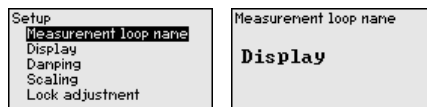

Setup - Display, menu language

This menu item allows a change of the national language.

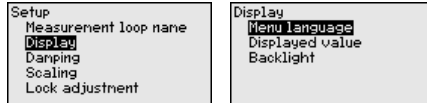

The following languages are available:

- German
- English
- French
- Spanish
- Russian
- Italian
- Dutch
- Portuguese
- Turkish
- Polish
- Czech
- Chinese
- Japanese

Setup - Display, indication value 1 to 4

In this menu item you define the indication of the measured values on the display. The selection comprises the current value in mA or as scaled value as well as the HART values PV, SV, TV, QV.

The display values can be adjusted separately.

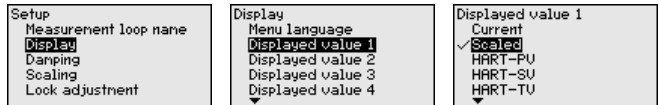

The default setting for the display value is "Current".

Setup - Display, lighting

The display and adjustment module has a backlight for the display. In this menu item you can switch on the lighting. You can find the required operating voltage in chapter "Technical data".

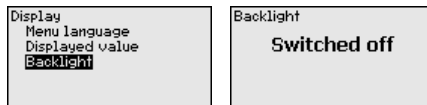

The lighting is switched off in delivery status.



Note:

The lighting switches off automatically when the current in the signal circuit is lower than 4 mA.

It switches on automatically when the current in the signal circuit is 4 mA or higher.

Setup - Damping

To damp process-dependent measured value fluctuations, set an integration time of 0 ... 999 s in this menu item. The increment is 0.1 s.

The entered integration time influences the current value and the display. The HART value remains unaffected.

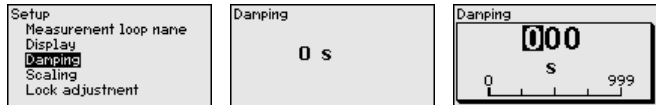

Factory setting is 0 s.

Setup - Scaling

In the menu item " *Scaling variable*" you define the scaling variable and unit of the measured value on the display, e.g. volume in l.

In addition to the offered standard units, there is the possibility, to create a user-defined unit.

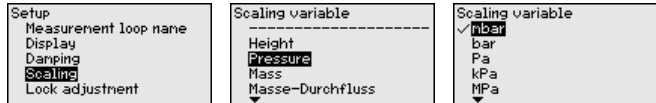

Furthermore, via menu item " *Scaling format*" you define the position of the comma and the assignment of the measured value for 0 % and 100 %.

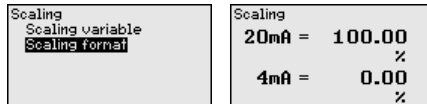

Lock/unlock setup - Adjustment

In the menu item " *Lock/unlock adjustment*", you can protect the instrument parameters against unauthorized modification. The PIN is activated/deactivated permanently.

With active PIN, only the following adjustment functions are possible without entering a PIN:

- Select menu items and show data
- Read data from the sensor into the display and adjustment module



Caution:

When the PIN is active, adjustment via PACTware/DTM as well as other systems is also blocked.

The PIN number is entered while locking.

Diagnostics - Device status

In this menu item, the device status is displayed.

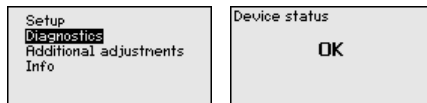

In case of instrument failure, an error code with text message is displayed. You can find information on cause and rectification in chapter " *Diagnosis and service*".

Additional settings - Reset

After a reset, certain parameter adjustments made by the user are reset.



The following reset functions are available:

Delivery status: Restores the parameter settings at the time of shipment Ex factory including the order-specific settings.

Basic settings: Resetting the parameter settings to the default values of the respective instrument.

The following table shows the default values of the instrument. Depending on the instrument version or application, all menu items may not be available or some may be differently assigned:

Reset - Setup

Menu item	Parameter	Basic settings
Measurement loop name		Display
Display	Language	-
	Displayed value	Signal current
	Backlight	Switched off
Damping	Integration time	0 s
Scaling	Scaling size	%
	Scaling format	20 mA correspond to 100.00 % 4 mA correspond to 0.00 %
Lock adjustment		Released

Reset - Additional settings

Menu item	Parameter	Basic settings
HART	HART mode	Secondary Master
	HART address	Address 0

Additional adjustments - Copy display settings

With this function, the display settings are copied.

The following parameters or settings are saved:

- All parameters of the menu " Setup" as well as the menu item " Additional adjustments - HART mode"



The copied data are permanently saved in the display and adjustment module. They remain even in case of voltage loss.

**Note:**

Before the data are stored in the instrument, they are checked to make sure they match the instrument. For this purpose, the instrument type of the source data as well as the target instrument are displayed. Storage takes place only after approval.

Additional adjustments - HART mode

With the parameter "*HART Master mode*" you define the instrument function as either Primary or Secondary Master.

The parameter "*HART address*", defines the address of the sensor VEGADIS 82 communicates with via HART.

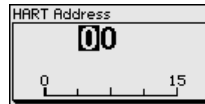
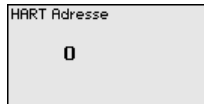
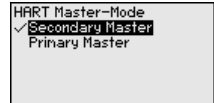
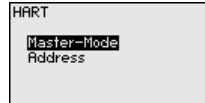
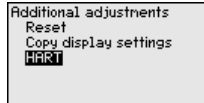

The factory setting is "*Secondary Master*" and the address 00.

Info - Instrument name

In this menu item, you can read out the instrument name and the instrument serial number:

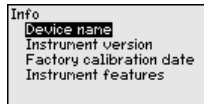
**Info - Instrument version**

In this menu item, the hardware and software version of the sensor is displayed.

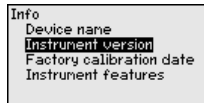
**Info - Factory calibration date**

In this menu item, the date of the factory calibration of the instrument as well as the date of the last change of sensor parameters is displayed via the PC.

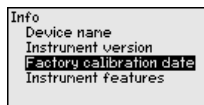
**Info - Instrument features**

In this menu item, instrument features such as approvals, electronics, housing as well as others are displayed.

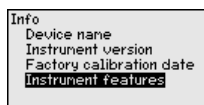

6.7 Parameter adjustment - VEGAPULS WL 61

Main menu

The main menu is divided into four areas with the following functions:

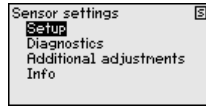

Setup: Settings, for example, for medium, application, vessel form, adjustment, signal output

Diagnosis: Information, for example on the instrument status, peak value, measurement reliability, echo curve memory as well as simulation

Additional adjustment: False signal suppression, linearization, reset

Info: Instrument type and serial number

Setup - Application

With this menu item you can adapt the sensor to the measurement conditions. The following options are available:

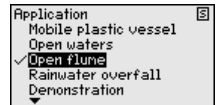
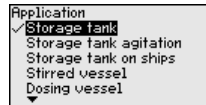
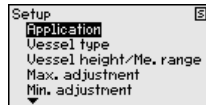

The selection "Standpipe" opens a new window in which the inner diameter of the applied standpipe is entered.

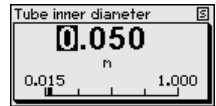
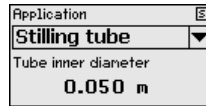
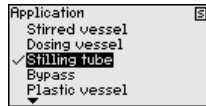

The following features form the basis of the applications:

Storage tank:

- Setup: large-volumed, upright cylindrical, spherical
- Medium speed: slow filling and emptying
- Process/measurement conditions:
 - Condensation
 - Smooth medium surface
 - Max. requirement to the measurement accuracy
- Properties, sensor:
 - Low sensitivity to sporadic false echoes
 - Stable and reliable measured values through averaging
 - High measurement accuracy
 - Short reaction time of the sensor not required

Storage tank with product circulation:

- Setup: large-volumed, upright cylindrical, spherical
- Medium speed: slow filling and emptying
- Vessel: small laterally mounted or large top mounted stirrer
- Process/measurement conditions:
 - Relatively smooth medium surface
 - Max. requirement to the measurement accuracy
 - Condensation

- Slight foam generation
- Overfilling possible
- Properties, sensor:
 - Low sensitivity to sporadic false echoes
 - Stable and reliable measured values through averaging
 - High measurement accuracy, because not set for max. speed
 - False signal suppression recommended

Storage tank on ships (Cargo Tank):

- Medium speed: slow filling and emptying
- Vessel:
 - Installations in the bottom section (bracers, heating spirals)
 - High nozzles 200 ... 500 mm, also with large diameters
- Process/measurement conditions:
 - Condensation, buildup by movement
 - Max. requirement on measurement accuracy from 95 %
- Properties, sensor:
 - Low sensitivity to sporadic false echoes
 - Stable and reliable measured values through averaging
 - High measurement accuracy
 - False signal suppression required

Stirrer vessel (reactor):

- Setup: all vessel sizes possible
- Medium speed:
 - Fast to slow filling possible
 - Vessel is filled and emptied very often
- Vessel:
 - Nozzle available
 - Large agitator blades of metal
 - Vortex breakers, heating spirals
- Process/measurement conditions:
 - Condensation, buildup by movement
 - Strong vortex generation
 - Very agitated surface, foam generation
- Properties, sensor:
 - Higher measurement speed through less averaging
 - Sporadic false echoes are suppressed

Dosing vessel:

- Setup: all vessel sizes possible
- Medium speed:
 - Fast filling and emptying
 - Vessel is filled and emptied very often
- Vessel: tight installation situation
- Process/measurement conditions:
 - Condensation, buildup on the antenna
 - Foam generation
- Properties, sensor:
 - Measurement speed optimized by virtually no averaging
 - Sporadic false echoes are suppressed
 - False signal suppression recommended

Standpipe:

- Medium speed: very fast filling and emptying
- Vessel:
 - Vent hole
 - Joins like flanges, weld joints
 - Shifting of the running time in the tube
- Process/measurement conditions:
 - Condensation
 - Buildup
- Properties, sensor:
 - Measurement speed optimized through little averaging
 - Entering the tube inside diameter takes the running time shift into consideration
 - Echo detection sensitivity reduced

Bypass:

- Medium speed:
 - Fast up to slow filling with short up to long bypass tube possible
 - Often the level is hold via a control facility
- Vessel:
 - Lateral outlets and inlets
 - Joins like flanges, weld joints
 - Shifting of the running time in the tube
- Process/measurement conditions:
 - Condensation
 - Buildup
 - Separation of oil and water possible
 - Overfilling into the antenna possible
- Properties, sensor:
 - Measurement speed optimized through little averaging
 - Entering the tube inside diameter takes the running time shift into consideration
 - Echo detection sensitivity reduced
 - False signal suppression recommended

Plastic tank:

- Vessel:
 - Instrument fix mounted or built in
 - Measurement through the vessel top, if appropriate to the application
 - With empty vessel, the measurement can go through the bottom
- Process/measurement conditions:
 - Condensation on the plastic ceiling
 - In outdoor facilities, water and snow on vessel top possible
- Properties, sensor:
 - False signals outside the vessel are not taken into consideration
 - False signal suppression recommended

Transportable plastic tank:

- Vessel:
 - Material and thickness different
 - Measurement through the vessel top

- Process/measurement conditions:
 - Measured value jump with vessel change
- Properties, sensor:
 - Quick adaptation to changing reflection conditions due to vessel change
 - False signal suppression required

Open water (gauge measurement):

- Rate of level change: slow level change
- Process/measurement conditions:
 - Large distance from sensor to water surface
 - Extreme damping of output signal due to wave generation
 - Ice and condensation on the antenna possible
 - Spiders and insects build nests in the antennas
 - Floating material and animals sporadically appear on water surface
- Properties, sensor:
 - Stable and reliable measured values through frequent averaging
 - Insensitive in the close range

Open flume (flow measurement):

- Rate of level change: slow level change
- Process/measurement conditions:
 - Ice and condensation on the antenna possible
 - Spiders and insects build nests in the antennas
 - Smooth water surface
 - Exact measurement result required
 - Distance to the water surface normally relatively large
- Properties, sensor:
 - Stable and reliable measured values through frequent averaging
 - Insensitive in the close range

Rain water spillover (weir):

- Rate of level change: slow level change
- Process/measurement conditions:
 - Ice and condensation on the antenna possible
 - Spiders and insects build nests in the antennas
 - Turbulent water surface
 - Sensor flooding possible
- Properties, sensor:
 - Stable and reliable measured values through frequent averaging
 - Insensitive in the close range

Demonstration:

- Setting for all applications which are not typically level measurement
 - Instrument demonstration
 - Object recognition/monitoring (additional settings required)
- Properties, sensor:

- Sensor accepts all measured value changes within the measuring range immediately
- High sensitivity to interference, because virtually no averaging



Caution:

If liquids with different dielectric constants separate in the vessel, for example through condensation, the radar sensor can detect under certain circumstances only the medium with the higher dielectric constant. Keep in mind that layer interfaces can cause faulty measurements.

If you want to measure the total height of both liquids reliably, please contact our service department or use an instrument specially designed for interface measurement.

Setup - Vessel form

Apart from the medium and the application, the vessel form itself can influence the measurement. To adapt the sensor to these measuring conditions, this menu item offers different options for vessel bottom and ceiling for certain applications.

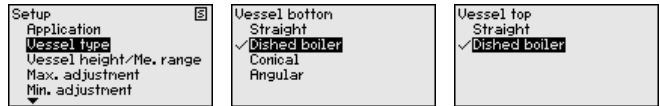

Enter the requested parameters via the appropriate keys, save your settings with **[OK]** and jump to the next menu item with the **[ESC]** and the **[->]** key.

Setup - Vessel height, measuring range

Through this selection the operating range of the sensor is adapted to the vessel height, which considerably increases measurement reliability under different basic conditions.

The min. adjustment must be carried out independently of this.

Enter the requested parameters via the appropriate keys, save your settings with **[OK]** and jump to the next menu item with the **[ESC]** and the **[->]** key.

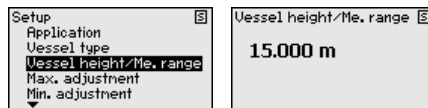

Setup - Adjustment

Since the radar sensor is a distance measuring instrument, the distance from the sensor to the medium surface is measured. To indicate the actual level, an allocation of the measured distance to the percentage height must be carried out.

To perform the adjustment, enter the distance with full and empty vessel, see the following example:

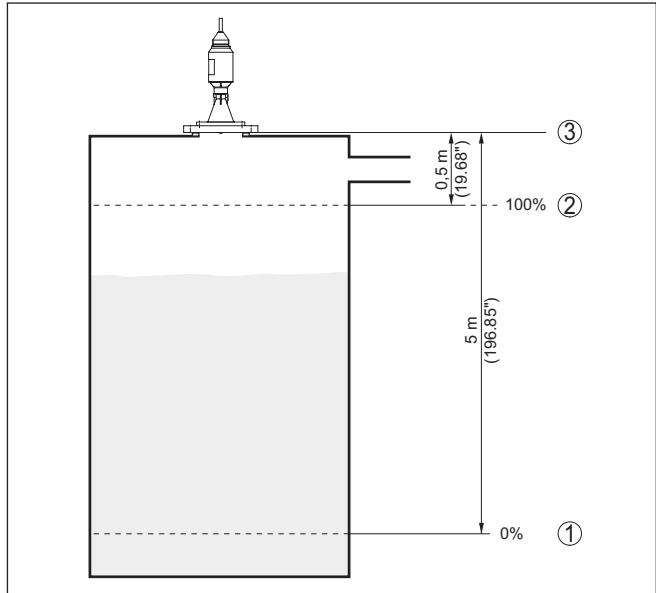

Fig. 21: Parameterisation example, Min./max. adjustment

- 1 Min. level = max. measuring distance
- 2 Max. level = min. measuring distance
- 3 Reference plane = Starting point for the measurement

If these values are not known, an adjustment with the distances of e.g. 10 % and 90 % is possible. Starting point for these distance specifications is always the sealing surface of the thread or flange. You can find specifications on the reference plane in chapter " *Technical data*". The actual level is calculated on the basis of these settings.

The actual product level during this adjustment is not important, because the min./max. adjustment is always carried out without changing the product level. These settings can be made ahead of time without the instrument having to be installed.

Setup - Max. adjustment

Proceed as follows:

1. Select with **[->]** the menu item " *Max. adjustment*" and confirm with **[OK]**.

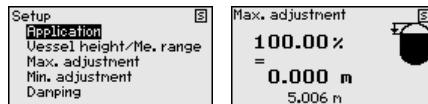

2. Prepare the percentage value for editing with **[OK]** and set the cursor to the requested position with **[->]**.

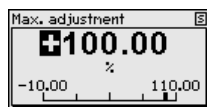

- Set the requested percentage value with **[+]** and save with **[OK]**.
The cursor jumps now to the distance value.

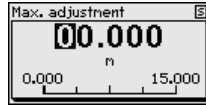

- Enter the appropriate distance value in m (corresponding to the percentage value) for the full vessel. Keep in mind that the max. level must lie below the min. distance to the antenna edge.
- Save settings with **[OK]**

Setup - Min. adjustment

Proceed as follows:

- Select the menu item "Setup" with **[>]** and confirm with **[OK]**.
Now select with **[>]** the menu item "Min. adjustment" and confirm with **[OK]**.

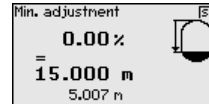
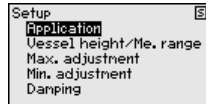

- Edit the percentage value with **[OK]** and set the cursor to the requested position with **[>]**.



- Set the requested percentage value with **[+]** and save with **[OK]**.
The cursor jumps now to the distance value.

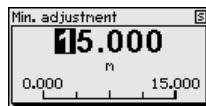

- Enter the suitable distance value in m for empty vessel (e.g. distance from the sensor to the vessel bottom) corresponding to the percentage value.
- Save settings with **[OK]** and move with **[ESC]** and **[>]** to the max. adjustment.

Setup - Damping

To damp process-dependent measured value fluctuations, set an integration time of 0 ... 999 s in this menu item.

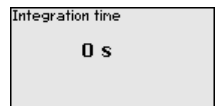
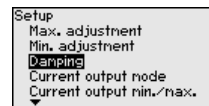
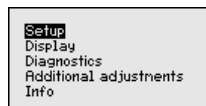

Depending on the sensor type, the factory setting is 0 s or 1 s.

Setup - Current output (mode)

In the menu item "Current output mode" you determine the output characteristics and reaction of the current output in case of fault.

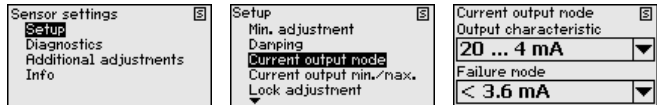

The default setting is output characteristics 4 ... 20 mA, fault mode < 3.6 mA

Setup - Current output (Min./Max.)

In the menu item " *Current output Min./Max.*", you determine the reaction of the current output during operation.

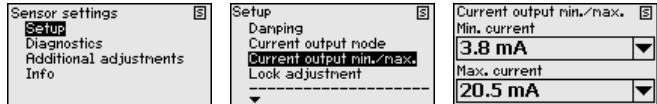

The default setting is min. current 3.8 mA and max. current 20.5 mA.

Setup - Lock adjustment

In this menu item, the PIN is activated/deactivated permanently. Entering a 4-digit PIN protects the sensor data against unauthorized access and unintentional modifications. If the PIN is activated permanently, it can be deactivated temporarily (i.e. for approx. 60 min.) in any menu item.

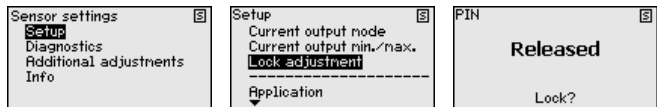

Only the following functions are permitted with activated PIN:

- Select menu items and show data
- Read data from the sensor into the display and adjustment module



Caution:

When the PIN is active, adjustment via PACTware/DTM as well as other systems is also blocked.

In delivery status, the PIN is " 0000".

Diagnostics - Device status

In this menu item, the device status is displayed.

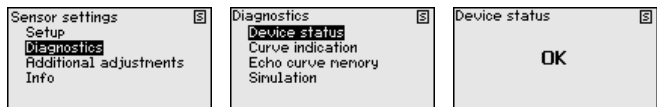

Diagnosis - Curve indication

The " *Echo curve*" shows the signal strength of the echoes over the measuring range in dB. The signal strength enables an evaluation of the quality of the measurement.

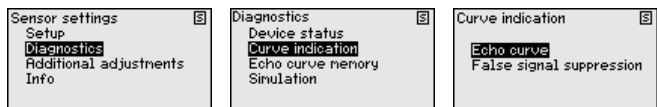

The " *False signal suppression*" displays the saved false echoes (see menu " *Additional settings*") of the empty vessel with signal strength in "dB" over the entire measuring range.

A comparison of echo curve and false signal suppression allows a more detailed statement about measurement reliability.

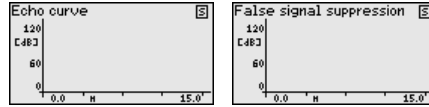

The selected curve is continuously updated. A submenu with zoom functions is opened with the **[OK]** key:

- "X-Zoom": Zoom function for the meas. distance
- "Y-Zoom": 1, 2, 5 and 10x signal magnification in " dB"
- "Unzoom": Reset the presentation to the nominal measuring range without magnification

Diagnostics - Echo curve memory

The function " *Echo curve memory*" allows the echo curve to be saved at the time of setup.



Note:

This is generally recommended, however, for use of the Asset Management functions it is absolutely necessary. Saving should be carried out with a very low level.

With the adjustment software PACTware and a PC, a high resolution echo curve can be displayed and used to recognize signal changes during operation. In addition, the echo curve of setup can be displayed in the echo curve window and compared with the current echo curve.

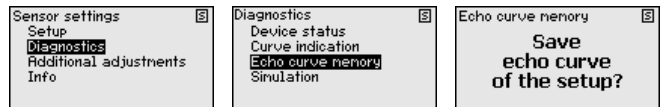

Diagnosis - Simulation

In this menu item you can simulate measured values via the current output. This allows the signal path to be tested, e.g. through downstream indicating instruments or the input card of the control system.

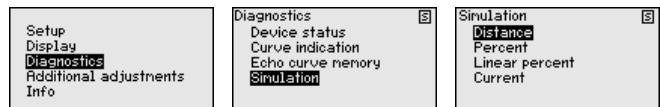

How to start the simulation:

1. Push **[OK]**
2. Select the requested simulation variable with **[>->]** and confirm with **[OK]**.
3. With **[OK]** you start the simulation, first of all the actual measured value is displayed in %
4. Start the editing mode with **[OK]**
5. Set the requested numerical value with **[+]** and **[>->]**.
6. Push **[OK]**

**Note:**

During simulation, the simulated value is output as 4 ... 20 mA current value and digital HART signal.

How to interrupt the simulation:

→ Push **[ESC]**

**Information:**

The simulation is automatically terminated 10 minutes after the last pressing of a key.

Additional settings - False signal suppression

The following circumstances cause interfering reflections and can influence the measurement:

- High mounting nozzles
- Vessel internals such as struts
- Agitators
- Buildup or welded joints on vessel walls

A false signal suppression detects, marks and saves these false signals to ensure that they are ignored in the level measurement.

**Note:**

This should be done with the lowest possible level so that all potential interfering reflections can be detected.

Proceed as follows:

1. Select menu item " *Additional settings* " with **[->]** and confirm with **[OK]**. With **[->]** select the menu item " *False signal suppression* " and confirm with **[OK]**.

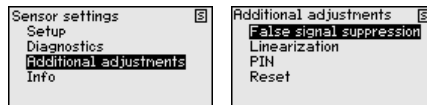

2. Confirm again with **[OK]**.



3. Confirm again with **[OK]**.

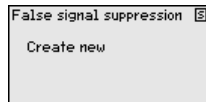

4. Confirm again with **[OK]** and enter the actual distance from the sensor to the product surface.

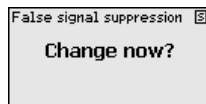

5. All interfering signals in this range are detected by the sensor and stored after being confirmed with **[OK]**.



Note:

Check the distance to the medium surface, because if an incorrect (too large) value is entered, the existing level will be saved as a false signal. The level would then no longer be detectable in this area.

If a false signal suppression has already been created in the sensor, the following menu window appears when selecting "False signal suppression":

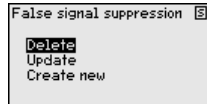

The menu item "Delete" is used to completely delete an already created false signal suppression. This is useful if the saved false signal suppression no longer matches the metrological conditions in the vessel.

The menu item "Extend" is used to extend an already existing false signal suppression. This is useful if a false signal suppression was carried out with a too high level and not all false signals could be detected. When selecting "Extend", the distance to the product surface of the created false signal suppression is displayed. This value can now be changed and the false signal suppression can be extended to this range.

Additional adjustments - Linearization curve

A linearization is necessary for all vessels in which the vessel volume does not increase linearly with the level - e.g. a horizontal cylindrical or spherical tank - and the indication or output of the volume is required. Corresponding linearization curves are preprogrammed for these vessels. They represent the correlation between the level percentage and vessel volume.

By activating the appropriate curve, the volume percentage of the vessel is displayed correctly. If the volume should not be displayed in percent but e.g. in l or kg, a scaling can be also set in the menu item "Display".

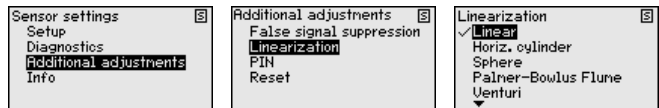

Enter the requested parameters via the appropriate keys, save your settings and jump to the next menu item with the [ESC] and [->] key.



Caution:

Note the following if instruments with appropriate approval are used as part of an overflow protection system according to WHG:

If a linearisation curve is selected, the measuring signal is no longer necessarily linear to the filling height. This must be considered by the user especially when setting the switching point on the limit signal transmitter.

Additional settings - Reset

After a reset, certain parameter adjustments made by the user are reset.

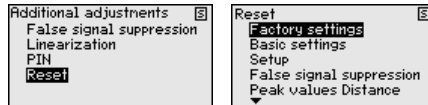

The following reset functions are available:

Delivery status: Restores the parameter settings at the time of shipment from the factory, incl. order-specific settings. Any stored false signal suppression or user-programmed linearisation curve, as well as the measured value memory, are deleted.

Basic settings: Restores the parameter settings, incl. special parameters, to the default values of the respective instrument. Any stored false signal suppression or user-programmed linearisation curve, as well as the measured value memory, are deleted.

Setup: Restores the parameter settings made in the menu item Setup to the default values of the respective instrument. False signal suppression, user-programmed linearisation curve, measured value memory and event memory remain untouched. The linearisation is set to linear.

False signal suppression: Deletes a previously created false signal suppression. The false signal suppression created at the factory remains active.

Peak values distance: Resetting the measured min. and max. distances to the actual measured value.

The following table shows the default values of the instrument. Depending on the instrument version, not all menu items are available or some may be differently assigned:

Menu	Menu item	Default value
Setup	Measurement loop name	Sensor
	Medium	Liquid/Water
	Application	Storage tank
	Vessel shape	Vessel bottom, dished form Vessel top, dished form
	Vessel height/ Measuring range	Recom. measuring range, see " <i>Technical data</i> " in the supplement
	Min. adjustment	Recom. measuring range, see " <i>Technical data</i> " in the supplement
	Max. adjustment	0,000 m(d)
	Damping	0.0 s
	Current output mode	4 ... 20 mA, < 3.6 mA
	Current output - Min./Max.	Min. current 3.8 mA, max. current 20.5 mA
	Lock adjustment	Released
Additional adjustments	Linearisation curve	Linear

Additional settings - PIN

Entering a 4-digit PIN protects the sensor data against unauthorized access and unintentional modification. In this menu item, the PIN is displayed or edited and changed. However, this menu item is only available if adjustment is enabled in the menu "Setup".

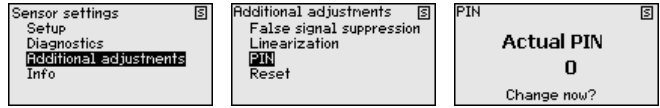

In delivery status, the PIN is "0000".

Info - Instrument name

In this menu item, you can read out the instrument name and the instrument serial number.

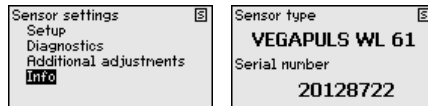

6.8 Parameter adjustment - VEGAWELL 52

Main menu

The main menu is divided into four areas with the following functions:

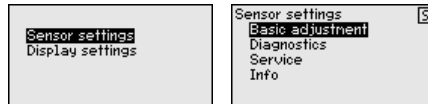

Basic adjustment: Settings, for example of the unit of measurement, position correction, adjustment, damping, signal output

Diagnosis: Information, for example, on device status, peak value

Service: Reset

Info: Instrument type and serial number

Basic adjustment - Adjustment unit

In this menu item, the adjustment units of the instrument are determined. The selection determines the unit displayed in the menu items "Min. adjustment (Zero)" and "Max. adjustment (Span)".

Unit of measurement:

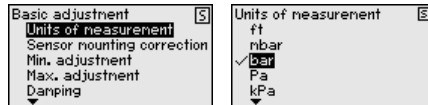

If the level should be adjusted in a height unit, the density of the medium must also be entered later during the adjustment.

Enter the requested parameters via the appropriate keys, save your settings with [OK] and jump to the next menu item with the [ESC] and the [->] key.

Basic adjustment - Position correction

The installation position of the instrument can shift the measured value (offset). The position correction compensates this offset. By doing so, the actual measured value is taken over automatically.



If the actual measured value should be taken over as correction value during automatic position correction, this value must not be influenced by product coverage or static pressure.

With the manual position correction, the offset value can be determined by the user. Select for this purpose the function "Edit" and enter the requested value.

Save your settings with **[OK]** and move with **[ESC]** and **[->]** to the next menu item.

After the position correction is carried out, the actual measured value is corrected to 0. The corrective value appears with an inverse sign as offset value in the display.

The position correction can be repeated as often as necessary. However, if the sum of the corrective values exceeds 20 % of the nominal measuring range, then no position correction is possible.

Parameterization example During adjustment, the pressure is entered e.g. for the level with full and empty vessel, see following example:

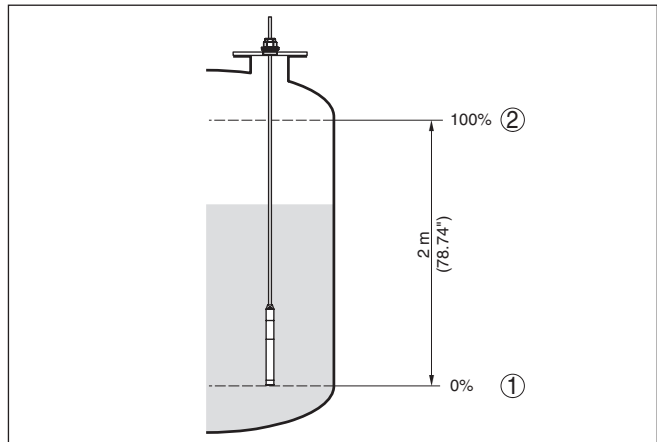

Fig. 22: Parameter adjustment example "Min./max. adjustment, level measurement"

- 1 Min. level = 0 % corresponds to 0.0 mbar
- 2 Max. level = 100 % corresponds to 196.2 mbar

If these values are not known, an adjustment with filling levels of e.g. 10 % and 90 % is also possible. By means of these settings, the real filling height is then calculated.

The real product level during the adjustment is not important, because the min./max. adjustment is always carried out without changing the product level. These settings can be made ahead of time without the instrument having to be installed.



Note:

If the adjustment ranges are exceeded, the entered value will not be accepted. Editing can be interrupted with **[ESC]** or corrected to a value within the adjustment ranges.

Basic adjustment - Min. adjustment

Proceed as follows:

1. Select the menu item "Setup" with **[>]** and confirm with **[OK]**.
Now select with **[>]** the menu item "Adjustment", then "Min. adjustment" and confirm with **[OK]**.

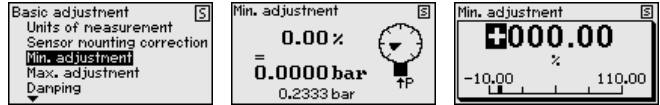

2. Edit the percentage value with **[OK]** and set the cursor to the requested position with **[>]**.
3. Set the requested percentage value (e.g. 10 %) with **[+]** and save with **[OK]**. The cursor jumps now to the pressure value.
4. Enter the pressure value corresponding to the min. level (e.g. 0 mbar).
5. Save settings with **[OK]** and move with **[ESC]** and **[>]** to the max. adjustment.

The min. adjustment is finished.

For an adjustment with filling, simply enter the actual measured value indicated at the bottom of the display.

Basic adjustment - Max. adjustment

Proceed as follows:

1. Select with **[>]** the menu item "Max. adjustment" and confirm with **[OK]**.

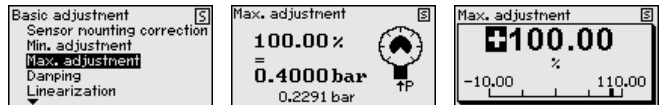

2. Edit the percentage value with **[OK]** and set the cursor to the requested position with **[>]**.
3. Set the requested percentage value (e.g. 90 %) with **[+]** and save with **[OK]**. The cursor jumps now to the pressure value.
4. Enter the pressure value for the full vessel (e.g. 900 mbar) corresponding to the percentage value.
5. Save settings with **[OK]**

The max. adjustment is finished.

For an adjustment with filling, simply enter the actual measured value indicated at the bottom of the display.

Basic adjustment - Damp- ing

To damp process-dependent measured value fluctuations, set an integration time of 0 ... 999 s in this menu item. The increment is 0.1 s.

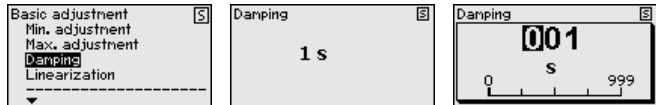

Factory setting is 0 s.

Basic adjustment - Linearization

A linearization is necessary for all vessels in which the vessel volume does not increase linearly with the level - e.g. a horizontal cylindrical or spherical tank - and the indication or output of the volume is required. Corresponding linearization curves are preprogrammed for these vessels. They represent the correlation between the level percentage and vessel volume. The linearization applies to the measured value indication and the current output.

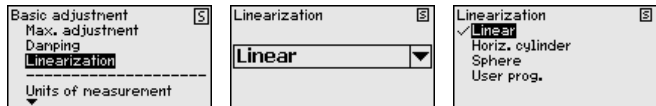

Caution:

Note the following, if the respective sensor is used as part of an overflow protection system according to WHG:

If a linearisation curve is selected, the measuring signal is no longer necessarily linear to the filling height. This must be considered by the user especially when setting the switching point on the limit signal transmitter.

Diagnostics - Device status

In this menu item, the device status is displayed.

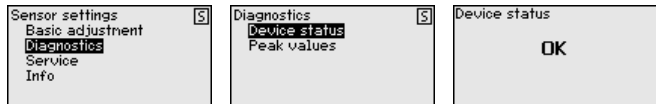

Diagnosis - Peak value

The respective min. and max. measured values are saved in the sensor. The two values are displayed in menu item "Peak values, pressure".

In another window you can carry out a reset of the peak values separately.

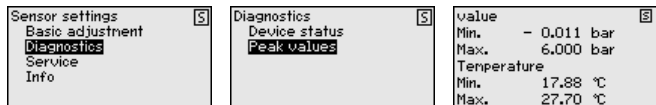

Service - Reset

After a reset, certain parameter adjustments made by the user are reset.

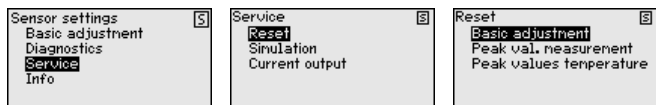

The following table shows the default values of the instrument:

Reset - Basic adjustment

Menu item	Parameter	Default value
Unit of measurement	Unit of measurement	mbar (with nominal measuring range ≤ 400 mbar) bar (with nominal measuring ranges ≥ 1 bar)
Position correction		0.00 bar
Adjustment	Min. adjustment	0.00 bar 0.00 %
	Max. adjustment	Nominal measuring range in bar 100.00 %
Damping	Integration time	0 s

Reset - Diagnosis

Menu item	Parameter	Default value
Peak value	Pressure	Actual measured value
	Temperature	Actual temperature value

Reset - Service

Menu item	Parameter	Default value
Current output	Mode	Output characteristics 4 ... 20 mA, failure mode < 3.6 mA.
	Min./Max.	Min. current 3.8 mA, max. current 20.5 mA

Service - Simulation

After a reset, certain parameter adjustments made by the user are reset.

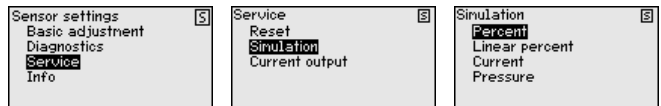

Service - Current output (mode)

In the menu item " *Current output mode*" you determine the output characteristics and reaction of the current output in case of fault.

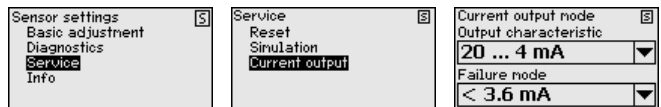

The default setting is output characteristics 4 ... 20 mA, fault mode < 3.6 mA.

Service - Current output (min./max.)

In the menu item " *Current output Min./Max.*", you determine the reaction of the current output during operation.

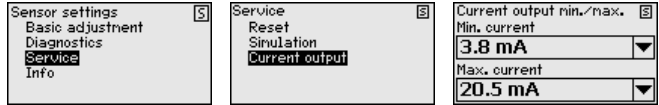

The default setting is min. current 3.8 mA and max. current 20.5 mA.

Info - Instrument name

In this menu item, you read out the instrument type and the serial number:



6.9 Parameter adjustment - Sensors from other manufacturers via Generic HART



Information:

The following menu contains only menu items in English. Switching to another language is not possible.

Sensor Settings

The menu " *Sensor settings*" is divided into 5 sections with the following function:

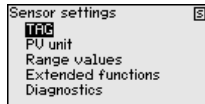

- TAG
 - Measurement loop designation
- PV unit
 - Unit of the Primary Value
- Range values
 - Measuring range begin and final value
- Extended functions
 - Damping, polling address, reset etc.
- Diagnostics
 - Device status, serial number, parameter change counter etc.

The submenu points are described below.

Sensor Settings - TAG

In the menu item " TAG" you edit a twelve-digit measurement loop designation.

The available digits include:

- Letters from A ... Z
- Numbers from 0 ... 9
- Special characters +, -, /, -

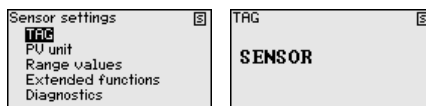

Sensor Settings - PV-Unit

In the menu item "PV unit" the unit of the output Primary Value is set, e.g. the filling height. The available units depend on the connected sensor.

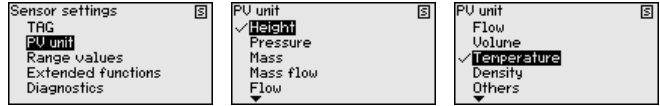

Sensor Settings - Range values

In the menu item "Range values" the measuring range begin and end value as well as the zero point of the sensor are determined. Furthermore the values can be edited or the current measured values accepted.

Proceed as follows:

1. Select with [->] the menu item "Range values" and confirm with [OK].

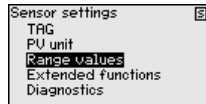

2. Select with [->] the menu item "PV Upper Range value" or "PV Lower Range value" and confirm with [OK]. The currently set values are displayed:



3. Select with [->] the menu item "Set PV Upper Range value" or "Set PV Lower Range value" and confirm with [OK].

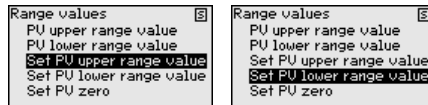

4. Confirm with [OK] the acceptance of the current measured value as new value for the range.

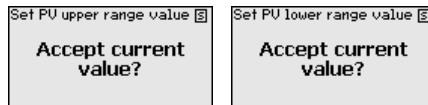

5. Select with [->] the menu item "Set PV zero" and confirm with [OK].

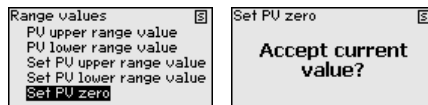

6. Confirm with [OK] the acceptance of the current measured value as new value for the zero.

The adjustment of the ranges is hence finished.

Extended functions

In the menu item " *Extended functions*" extended sensor functions are set.



The functions are described below.

Extended functions - PV-Damping

For damping of process-related measured value fluctuations, set an integration time for the Primary Value in the menu item " *PV-Damping*".

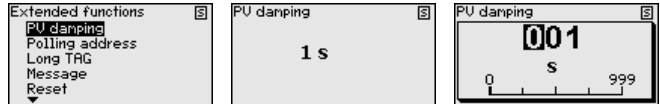
**Extended functions - Polling Address**

The parameter " *Polling address*", defines the address of the sensor VEGADIS 82 communicates with via HART.

It is furthermore determined if the current in the signal circuits is fixed set to 4 mA or is variable with the measured value 4 ... 20 mA.

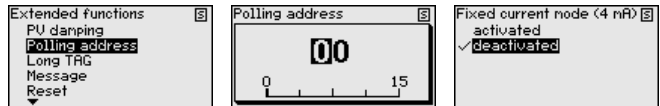
**Extended functions - Long TAG**

In the menu item " *Long TAG*" you edit the first 16 positions of a 32-digit HART measurement loop identification for the sensor.

**Extended functions - Message**

In the menu item " *Message*" you edit the first 16 positions of a 24-digit message stored in the sensor for polling.

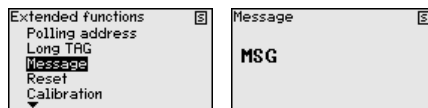
**Extended functions - Reset**

In the menu item " *Reset*" you trigger a restart of the connected sensor. The signal cable is not interrupted.

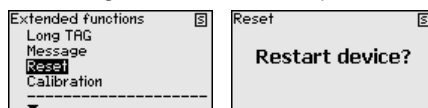
**Extended functions - Calibration**

In the menu item " *Calibration*" set a current for the signal circuit deviating from 4 mA (Trim loop current zero) or 20 mA (Trim loop current gain).

If the measured value uses the Lower Range Value, the current in the signal circuit uses the value set here. The same applies to the Upper Range Value.

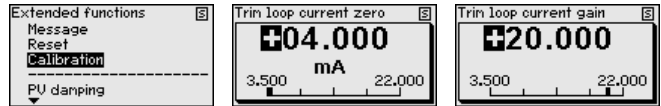

Diagnostics

Various diagnosis functions are available in the menu item "Diagnostics".

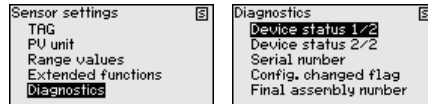

The functions are described below.

Diagnostics - Device Status

In the menu item "Device Status" information about the device status can be retrieved. The device status includes sensor malfunctions, power supply interruptions, signal circuit specifications as well as measured values outside the specified range.



Diagnostics - Serial Number

In the menu item "Serial Number" the serial number is retrieved.

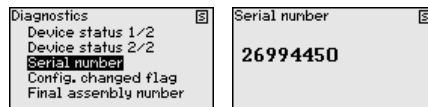

Diagnostics - Config. changed flag

In the menu item "Config. changed flag" the number of parameter changes carried out is retrieved. Reset resets this value to zero again.



Diagnostics - Final assembly number

The menu item "Final assembly number" identifies the edition of the device. Upgraded on site such as e.g. on the electronics or mechanics can thus be traced and referenced for plant documentation.

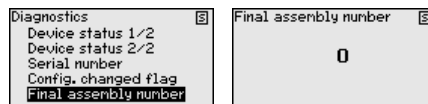

7 Setup via PACTware

7.1 Connect the PC

Via interface adapter

The PC is connected via the interface adapter to the device.

Parameter adjustment options:

- VEGADIS 82
- Sensor

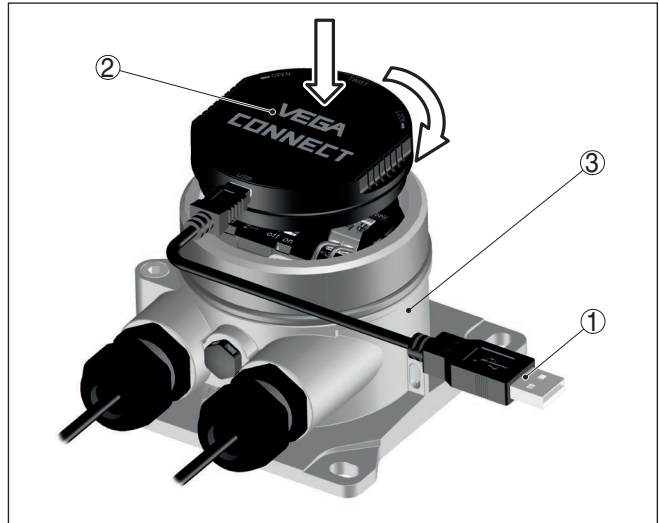

Fig. 23: Connection of the PC via interface adapter

- 1 USB cable to the PC
- 2 Interface adapter
- 3 VEGADIS 82

Via HART modem

The PC is connected via a HART modem to the sensor side of the VEGADIS 82.

Parameter adjustment options:

- Sensor

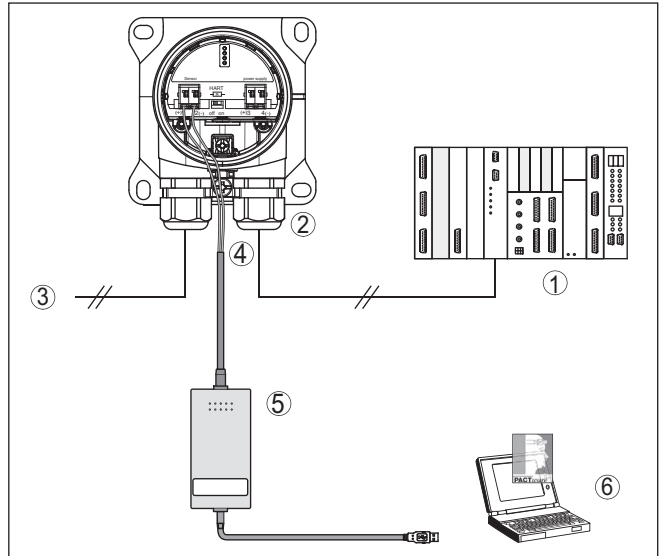

Fig. 24: Connecting the PC via HART to the signal cable

- 1 Processing system/PLC/Voltage supply
- 2 VEGADIS 82
- 3 To the sensor
- 4 Connection cable with 2 mm pins and terminals
- 5 HART modem
- 6 PC

7.2 Parameter adjustment with PACTware

Prerequisites

For parameter adjustment of the instrument via a Windows PC, the configuration software PACTware and a suitable instrument driver (DTM) according to FDT standard are required. The latest PACTware version as well as all available DTMs are compiled in a DTM Collection. The DTMs can also be integrated into other frame applications according to FDT standard.



Note:

To ensure that all instrument functions are supported, you should always use the latest DTM Collection. Furthermore, not all described functions are included in older firmware versions. You can download the latest instrument software from our homepage. A description of the update procedure is also available in the Internet.

Further setup steps are described in the operating instructions manual "DTM Collection/PACTware" attached to each DTM Collection and which can also be downloaded from the Internet. Detailed descriptions are available in the online help of PACTware and the DTMs.

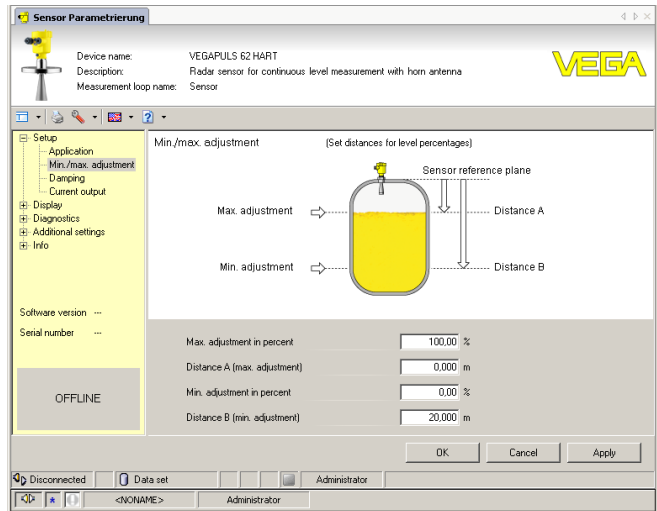

Fig. 25: Example of a DTM view

Standard/Full version

All device DTMs are available as a free-of-charge standard version and as a full version that must be purchased. In the standard version, all functions for complete setup are already included. An assistant for simple project configuration simplifies the adjustment considerably. Saving/printing the project as well as import/export functions are also part of the standard version.

In the full version there is also an extended print function for complete project documentation as well as a save function for measured value and echo curves. In addition, there is a tank calculation program as well as a multiviewer for display and analysis of the saved measured value and echo curves.

The standard version is available as a download under www.vega.com/downloads and "Software". The full version is available on CD from the agency serving you.

7.3 Saving the parameterisation data

We recommend documenting or saving the parameterisation data via PACTware. That way the data are available for multiple use or service purposes.

8 Diagnostics and servicing

8.1 Maintenance

Maintenance

If the device is used properly, no special maintenance is required in normal operation.

Cleaning

The cleaning helps that the type label and markings on the instrument are visible.

Take note of the following:

- Use only cleaning agents which do not corrode the housings, type label and seals
- Use only cleaning methods corresponding to the housing protection rating

8.2 Diagnostics

Sensors

The instrument supports the self-monitoring and diagnosis of the connected sensor. Status or failure messages are displayed according to the sensor via display and adjustment module, PACTware/DTM and EDD.

You can find a detailed overview of this function in the operating instructions of the respective sensor.

External display and adjustment unit

The following table shows the error codes and text messages of the VEGADIS 82 and gives information on the cause and removal.

Code Text message	Cause	Rectification
S003 CRC-error	CRC error during self-check	Carry out a reset Send instrument for repair
F008 Sensor not found	Sensor in boot phase HART communication malfunctioning	Check sensor connection Check HART address sensor
F013 Sensor or measurement loop malfunctioning	Sensor signals error, no valid measured value	Check sensor parameter adjustment Send instrument for repair
F014 Sensor input: Short-circuit	Short-circuit or sensor current > 21 mA	Check cable Check sensor
F015 Sensor input: Line break	Line break or sensor current < 3.6 mA	Check cable Check sensor, probably already in the run-in period
S021 Scaling: Span too small	Scaling span too small	Carry out scaling again Increase the distance between min. and max. scaling

Code Text message	Cause	Rectification
S022 Scaling: Value too high	Scaling value too high	Check scaling values, correct, if necessary
S030 Measured value: not valid	Sensor in boot phase Measured value not valid	Check sensor parameter adjustment
F034 EEPROM: CRC error	EEPROM: CRC error	Switch the instrument off and on Carry out reset to default setting Send instrument for repair
F035 ROM: CRC error	ROM: CRC error	Switch the instrument off and on Carry out reset to default setting Send instrument for repair
F036 No executable software version	Instrument software not executable (during software update or after failed update)	Wait until software update is finished Carry out another software update
F037 RAM defective	Error of the RAM in the internal data memory	Switch the instrument off and on Carry out reset to default setting Send instrument for repair
F040 General hardware error	Hardware error	Switch the instrument off and on Carry out reset to default setting Send instrument for repair
S053 Sensor measuring range too small	Sensor measuring range not read correctly	HART communication error: Check sensor cable and screening Switch the instrument off and on

8.3 Rectify faults

Reaction when malfunction occurs

The operator of the system is responsible for taking suitable measures to rectify faults.

4 ... 20 mA signal

Connect a multimeter in the suitable measuring range according to the wiring plan. The following table describes possible errors in the current signal and helps to eliminate them:

Error	Cause	Rectification
4 ... 20 mA signal not stable	Fluctuating measured value	Set damping
4 ... 20 mA signal missing	Electrical connection faulty	Check connection, correct, if necessary
	Voltage supply missing	Check cables for breaks; repair if necessary
	Operating voltage too low, load resistance too high	Check, adapt if necessary
Current signal greater than 22 mA, less than 3.6 mA	Sensor electronics defective	Replace device or send in for repair depending on device version

Reaction after fault rectification

Depending on the reason for the fault and the measures taken, the steps described in chapter " *Setup*" must be carried out again or must be checked for plausibility and completeness.

24 hour service hotline

Should these measures not be successful, please call in urgent cases the VEGA service hotline under the phone no. **+49 1805 858550**.

The hotline is also available outside normal working hours, seven days a week around the clock.

Since we offer this service worldwide, the support is provided in English. The service itself is free of charge, the only costs involved are the normal call charges.

8.4 Exchanging the electronics module

In case of a defect, the user can replace the electronics module with another one of identical type.



In Ex applications, only instruments and electronics modules with appropriate Ex approval may be used.

If there is no electronics module available on site, one can be ordered from the agency serving you.

8.5 Software update

The following components are required to update the instrument software:

- Instrument
- Voltage supply
- Interface adapter VEGACONNECT
- PC with PACTware
- Current instrument software as file

You can find the current instrument software as well as detailed information on the procedure in the download area of our homepage: www.vega.com.

You can find information about the installation in the download file.

**Caution:**

Instruments with approvals can be bound to certain software versions. Therefore make sure that the approval is still effective after a software update is carried out.

You can find detailed information in the download area at www.vega.com.

8.6 How to proceed if a repair is necessary

You can find an instrument return form as well as detailed information about the procedure in the download area of our homepage. By doing this you help us carry out the repair quickly and without having to call back for needed information.

In case of repair, proceed as follows:

- Print and fill out one form per instrument
- Clean the instrument and pack it damage-proof

- Attach the completed form and, if need be, also a safety data sheet outside on the packaging
- Ask the agency serving you to get the address for the return shipment. You can find the agency on our homepage.

9 Dismount

9.1 Dismounting steps

**Warning:**

Before dismantling, be aware of dangerous process conditions such as e.g. pressure in the vessel or pipeline, high temperatures, corrosive or toxic media etc.

Take note of chapters "*Mounting*" and "*Connecting to voltage supply*" and carry out the listed steps in reverse order.

9.2 Disposal

The instrument consists of materials which can be recycled by specialised recycling companies. We use recyclable materials and have designed the electronics to be easily separable.

WEEE directive

The instrument does not fall in the scope of the EU WEEE directive. Article 2 of this Directive exempts electrical and electronic equipment from this requirement if it is part of another instrument that does not fall in the scope of the Directive. These include stationary industrial plants.

Pass the instrument directly on to a specialised recycling company and do not use the municipal collecting points.

If you have no way to dispose of the old instrument properly, please contact us concerning return and disposal.

10 Supplement

10.1 Technical data

Materials and weights

Materials

- | | |
|--------------------------------------------------------------------------------------|---------------------------------------------------------------------|
| – Plastic housing | Plastic PBT (Polyester) |
| – Aluminium housing | Aluminium die-casting AlSi10Mg, powder-coated (Basis: Polyester) |
| – Stainless steel housing | 316L precision casting, blasted |
| – Seal between housing and housing lid | NBR (stainless steel housing), silicone (Aluminium/plastic housing) |
| – Inspection window in housing cover (in version with display and adjustment module) | Polycarbonate, coated |
| – Cable gland/Seal insert | PA/NBR |
| – Ground terminal | 316L |

Deviating materials - Ex-d version

- | | |
|--------------------------------------------------------------------------------------|--------------------------|
| – Inspection window in housing cover (in version with display and adjustment module) | Single-pane safety glass |
| – Cable gland/Seal insert | Brass nickel-plated/NBR |

Materials for carrier rail mounting

- | | |
|------------------------------------|------------------|
| – Adapter plate, housing side | 316 |
| – Adapter plate, carrier rail side | Zinc die casting |
| – Mounting screws | 316 |

Materials for tube mounting

- | | |
|-------------------|------|
| – Brackets | StSt |
| – Mounting screws | StSt |

Materials for panel mounting

- | | |
|---------------------|-------------------|
| – Housing | PPE |
| – Transparent cover | PS |
| – Screw clamps | St, nickel plated |

Material sun protection

316L

Weights without mounting elements approx.

- | | |
|---------------------------|---------------------|
| – Plastic housing | 0.35 kg (0.772 lbs) |
| – Aluminium housing | 0.7 kg (1.543 lbs) |
| – Stainless steel housing | 2.0 kg (4.409 lbs) |

Mounting elements approx.

- | | |
|-------------------------------------------|--------------------|
| – Brackets for tube mounting | 0.4 kg (0.882 lbs) |
| – Adapter plate for carrier rail mounting | 0.5 kg (1.102 lbs) |

Torques

Max. torque for NPT cable glands and Conduit tubes

- Plastic housing 10 Nm (7.376 lbf ft)
- Aluminium/Stainless steel housing 50 Nm (36.88 lbf ft)

Signal and supply circuit

Operating voltage max. 35 V DC

Voltage drop with current value 4 ... 20 mA

- Without lighting max. 1.7 V
- With lighting max. 3.2 V
- With activated HART resistance additionally max. 4.5 V

HART resistance 200 Ω

Current range 3.5 ... 22.5 mA ¹⁾

Overcurrent resistance 100 mA

Reverse voltage protection Available

Functional safety SIL non-reactive

Current measurement (reference temperature 20 °C)

Measuring range loop current 3.5 ... 22.5 mA

Deviation ±0.1 % of 20 mA

Temperature coefficient ±0.1 % of the span/10 K

Interval 250 ms

Display and adjustment module

Display element Display with backlight

Measured value indication

- Number of digits 5

Adjustment elements

- 4 keys *[OK], [->], [+], [ESC]*

Protection rating

- unassembled IP20
- Mounted in the housing without lid IP40

Materials

- Housing ABS
- Inspection window Polyester foil

Functional safety SIL non-reactive

Adjustment elements

Slide switch in the connection compartment Activating/deactivating the integrated HART resistor

¹⁾ If the loop current is not sufficient for operation, the display does not work. When the measured values are outside the measuring range, a message is displayed instead of the measured value.

Ambient conditions

Storage and transport temperature	-40 ... +80 °C (-40 ... +176 °F)
Ambient temperature	
– without display and adjustment module	-40 ... +80 °C (-40 ... +176 °F)
– With display and adjustment module	-20 ... +70 °C (-4 ... +158 °F)

Process conditions

Vibration resistance	4 g at 5 ... 200 Hz according to EN 60068-2-6 (vibration with resonance)
Vibration resistance with carrier rail mounting	1 g at 5 ... 200 Hz according to EN 60068-2-6 (vibration with resonance)
Shock resistance	100 g, 6 ms according to EN 60068-2-27 (mechanical shock)

Electromechanical data

Options of the cable entry

– Cable entry	M20 x 1.5, ½ NPT
– Cable gland	M20 x 1.5, ½ NPT
– Blind plug	M20 x 1.5; ½ NPT
– Closing cap	½ NPT

Connection terminals

– Type	Spring-loaded terminal
– Stripping length	8 mm

Wire cross-section of the connection cable (according to IEC 60228)

– Massive wire, stranded wire	0.2 ... 2.5 mm ² (AWG 24 ... 14)
– Stranded wire with end sleeve	0.2 ... 1.5 mm ² (AWG 24 ... 16)

Electromechanical data - Panel mounting

Terminals, plug connector

– Type	Spring-loaded terminal
– Stripping length	8 mm

Wire cross-section of the connection cable (according to IEC 60228)

– Massive wire, stranded wire	0.2 ... 1.5 mm ² (AWG 24 ... 16)
– Stranded wire with end sleeve	0.25 ... 0.75 mm ² (AWG 24 ... 18)

Electrical protective measures

Protection rating

– Plastic housing	IP66/IP67 acc. to IEC 60529, Type 4X acc. to NEMA
– Housing for panel mounting (mounted)	IP40 acc. to IEC 60529, Type 1 acc. to NEMA
– Aluminium/Stainless steel housing	IP66/IP68 (0.2 bar) acc. to IEC 60529, type 6P acc. to NEMA

Connection of the feeding power supply unit Networks of overvoltage category III

Altitude above sea level

- by default up to 2000 m (6562 ft)
- with connected overvoltage protection up to 5000 m (16404 ft)

Pollution degree ²⁾ 4

Protection class II

10.2 HART communication, HART commands

HART is a bidirectional communication protocol enabling the data access between intelligent field devices and host systems.

The digital HART signal is formed from the frequencies 1200 and 2200 Hz, which represent bit information 1 and 0 respectively. The frequency changeover (FSK = frequency shift keying) used is based on the Bell 202 data communication standard. 202 data communication standard.

The digital signal contains information from the device, including PV, device status, diagnosis and additional measured or calculated values etc.

The VEGADIS 82 supports the HART commands listed below.

You can find further information on HART under <https://fieldcommgroup.org>.

Supported HART commands

Command-No.	Command-Name	Function
00	Device serial number, Revision levels	Read
01	PV Unit	Read
03	Dynamic Variables and Loop Current	Read
06	Polling address	Write
07	Loop Configuration	Read
12	Message	Read
13	Tag	Read
15	PV-Upper/-Lower range Value/-Damping	Read
16	Final assembly number	Read
17	Message	Write
18	Tag	Write
20	Long Tag	Read
22	Long Tag	Write
34	PV-damping	Write
35	Upper/Lower range Value	Write
36	Set upper range value	Write
37	Set lower range value	Write
38	Reset Config changed flag	Write
40	Enter/Exit Fixed Current Mode	Write

²⁾ When used with fulfilled housing protection

Command-No.	Command-Name	Function
42	Restart device	Write
43	Set PV zero	Write
44	PV Unit	Write
45	Trim loop current zero	Write
45	Trim Loop current gain	Write

10.3 Dimensions

VEGADIS 82, plastic housing

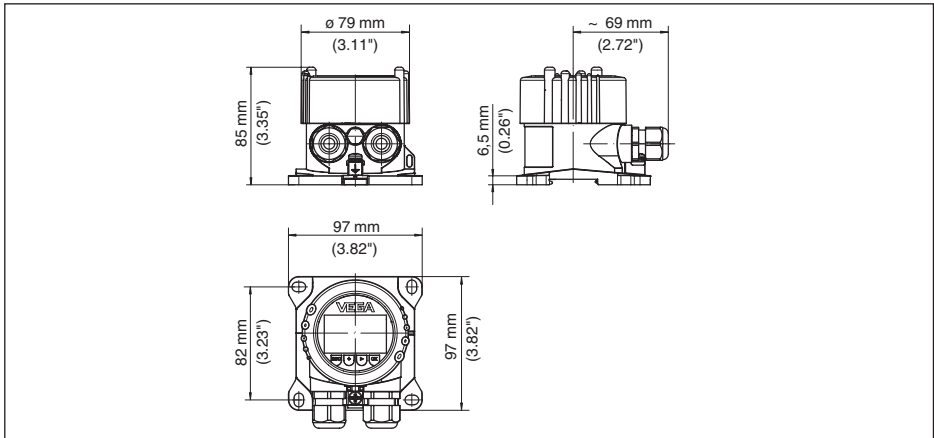

Fig. 26: VEGADIS 82 with plastic housing

VEGADIS 82, plastic housing (panel mounting)

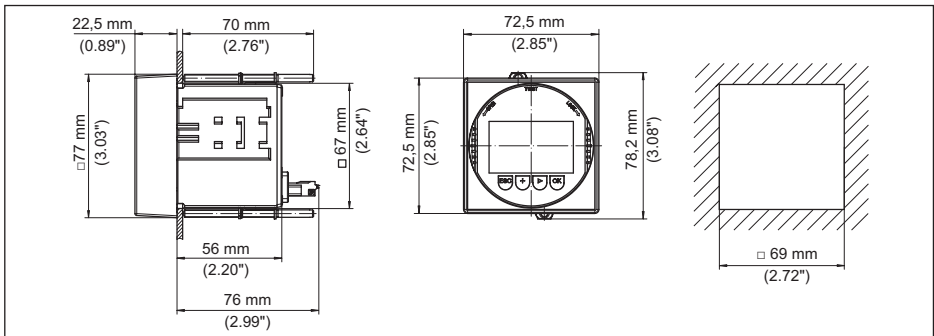

Fig. 27: VEGADIS 82 with plastic housing for panel mounting

VEGADIS 82, aluminium housing

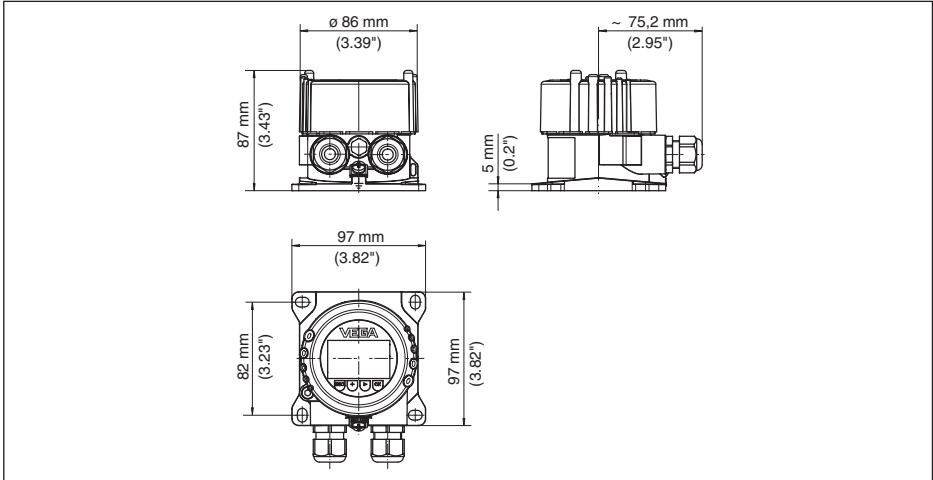

Fig. 28: VEGADIS 82 with Aluminium housing

VEGADIS 82, Stainless steel housing (precision casting)

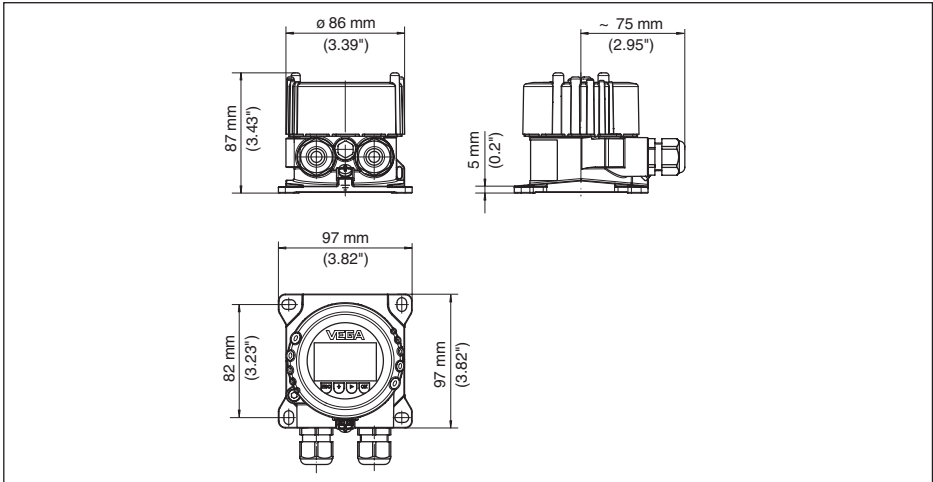

Fig. 29: VEGADIS 82, with stainless steel housing (precision casting)

Mounting elements

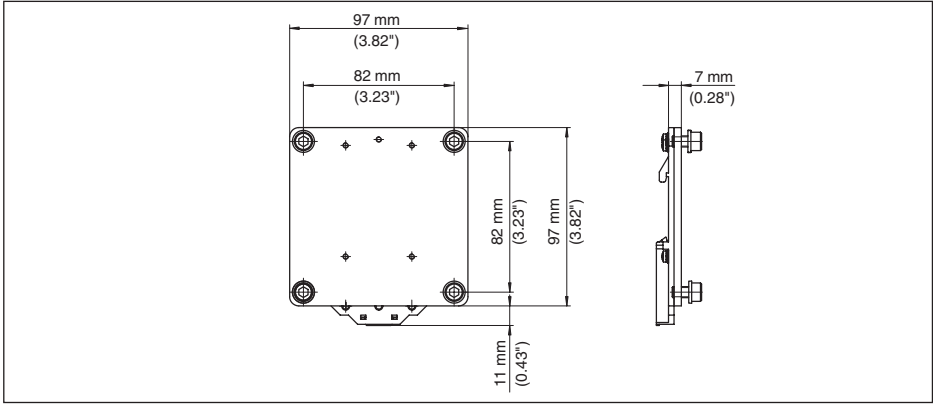

Fig. 30: Adapter plate for carrier rail mounting of VEGADIS 82

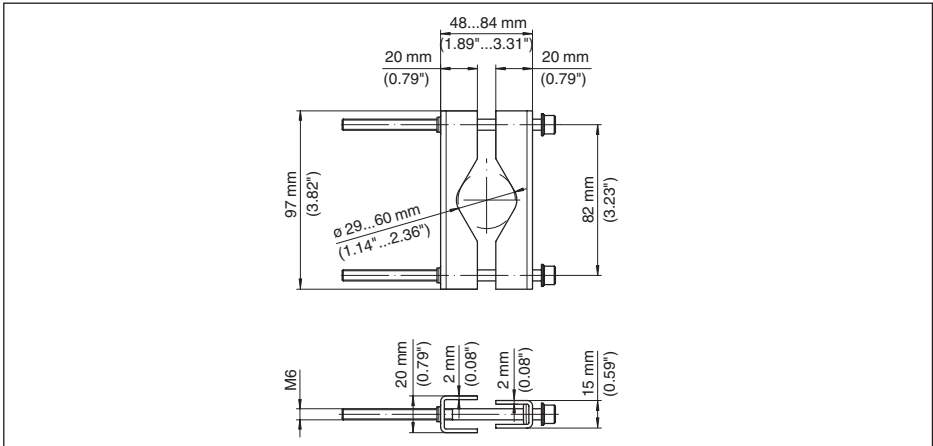

Fig. 31: Brackets for tube mounting of VEGADIS 82

10.4 Industrial property rights

VEGA product lines are global protected by industrial property rights. Further information see www.vega.com.

VEGA Produktfamilien sind weltweit geschützt durch gewerbliche Schutzrechte.

Nähere Informationen unter www.vega.com.

Les lignes de produits VEGA sont globalement protégées par des droits de propriété intellectuelle. Pour plus d'informations, on pourra se référer au site www.vega.com.

VEGA lineas de productos están protegidas por los derechos en el campo de la propiedad industrial. Para mayor información revise la pagina web www.vega.com.

Линии продукции фирмы ВЕГА защищаются по всему миру правами на интеллектуальную собственность. Дальнейшую информацию смотрите на сайте www.vega.com.

VEGA系列产品在全球享有知识产权保护。

进一步信息请参见网站 < www.vega.com。

10.5 Trademark

All the brands as well as trade and company names used are property of their lawful proprietor/originator.

INDEX**A**

- Adjustment 36, 37, 44
 - Max. adjustment 45
 - Min. adjustment 45
 - System 25
- Adjustment menu 26, 43
- Application area 8

C

- Calibration 50
- Change the language 26
- Check output signal 56
- Connection
 - Cable 15
 - Steps 16
 - Technology 16
- Copy sensor settings 29
- Current output 37, 38, 47
- Curve display
 - Echo curve 38
 - False signal suppression 38

D

- Damping 27, 37, 45
- Default values 29, 42, 46
- Display lighting 27

E

- Echo curve of the setup 39
- Error codes 55
- Extended functions 50

F

- False signal suppression 40

G

- Grounding 16

H

- HART mode 30

I

- Instrument versions 7

L

- Linearisation 46
- Linearisation curve 41
- Lock adjustment 28, 38
- Long TAG 50

M

- Main menu 31
- Message 50
- Modes 9
- Mounting
 - Carrier rail 12
 - Front panel 14
 - Position 12
 - Tube 13

O

- Overfill protection according to WHG 41

P

- Peak value indicator
 - Pressure 46
- PIN 43
- Polling Address 50
- Position correction 43
- PV-Damping 50
- PV-Unit 49

R

- Range values 49
- Repair 57
- Reset 29, 41, 46, 50

S

- Scaling 28
- Sensor status 38
- Service hotline 57
- Set display parameters 27
- Simulation 39, 47

T

- Type label 7

V

- Vessel
 - Vessel height 35
 - Vessel shape 35
- Voltage supply 15







Printing date:

VEGA

All statements concerning scope of delivery, application, practical use and operating conditions of the sensors and processing systems correspond to the information available at the time of printing.

Subject to change without prior notice

© VEGA Grieshaber KG, Schiltach/Germany 2021



45300-EN-210216

VEGA Grieshaber KG
Am Hohenstein 113
77761 Schiltach
Germany

Phone +49 7836 50-0
E-mail: info.de@vega.com
www.vega.com